



# 12







Stekers & stekerdozen

Plugs & sockets

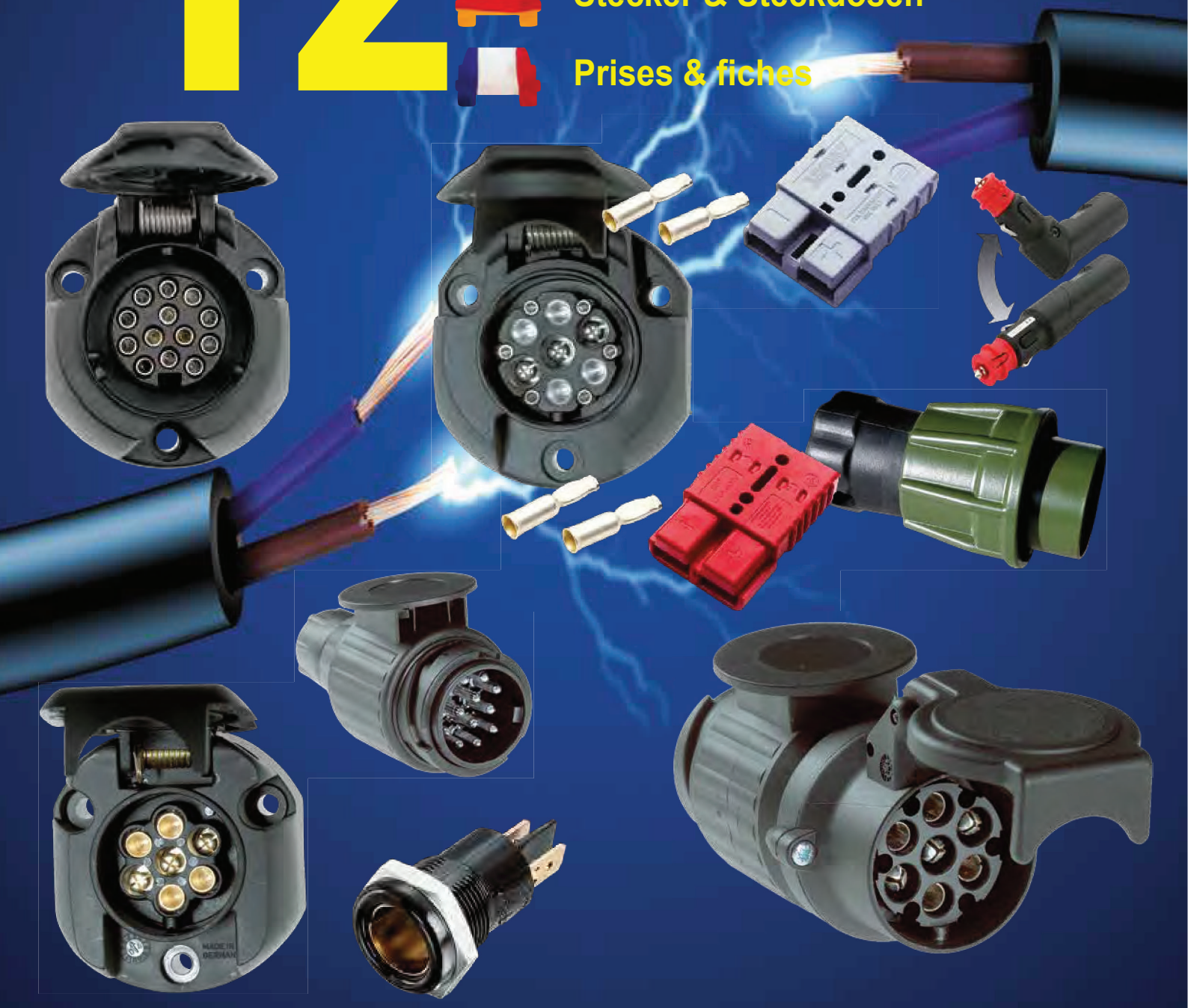
Stecker & Steckdosen

Prises & fiches





-  Stekers 1 polig - universeel - met trekontlasting
-  Plugs 1 pin - universal - with pull relief
-  Universal Stecker 1 Polig - Zugentlastung
-  Fiches à 1 pôle- universel - avec serre-câble

DIN / ISO 4165





SD.002

V 12 - 24 V W 15 A  
 12 mm  
 max. 2.5 mm<sup>2</sup>  
 vpe 1





SD.431

V 12 - 24 V W 15 A  
 12 mm  
 max. 2.5 mm<sup>2</sup>  
 vpe 1





SD.001

V 12 - 24 V W 8 A  
 12 / 20.4 mm  
 max. 2.5 mm<sup>2</sup>  
 vpe 1





SD.003

V 12 - 24 V W 16 A  
 12 / 20.4 mm  
 max. 2.5 mm<sup>2</sup>  
 vpe 1





SD.016

V 12 - 24 V W 8 A  
 12 / 20.4 mm  
 max. 2.5 mm<sup>2</sup>  
 vpe 1





SD.017

V 12 - 24 V W 8 A  
 12 / 20.4 mm  
 max. 2.5 mm<sup>2</sup>  
 X  
 vpe 1





SD.421

V 12 - 24 V W 16 A  
 12 / 20.4 mm  
 max. 2.5 mm<sup>2</sup>  
 X  
 vpe 1





SD.422

V 12 - 24 V W 16 A  
 12 / 20.4 mm  
 max. 2.5 mm<sup>2</sup>  
 X  
 vpe 1









SD.018

V 12 - 24 V W 7.5 A  
 12 / 20.4 mm  
 max. 2.5 mm<sup>2</sup>  
 X  
 vpe 1



SD.423

V 12 - 24 V W 8 A  
 12 / 20.4 mm  
 max. 2.5 mm<sup>2</sup>  
 vpe 1

-  Stekerdozen 1 polig - universeel
-  Sockets 1 pin - universal
-  Universal Steckdosen 1 Polig
-  Prises à 1 pôle - universel

DIN / ISO 4165



SD.004

V 12 - 24 V W 16 A  
 18 mm  
 vpe 1



SD.019

V 12 - 24 V W 16 A  
 18 mm  
 vpe 1



SD.020

V 12 - 24 V W 16 A  
 18 mm  
 vpe 1



SD.005

V 12 - 24 V W 16 A  
 18.5 mm  
 vpe 1



SD.012  
 massa ring / earth ring /  
 Masseklemme / clip en masse



SD.014

V 12 - 24 V W 16 A  
 18.5 mm  
 vpe 1



SD.464

V 12 - 24 V W 12 A  
 18.5 mm  
 vpe 1







SD.465

V 12 - 24 V W 12 A  
 18.5 mm  
 vpe 1



SD.011

V 12 - 24 V W 20 A  
 20.95 mm  
 vpe 1

-  Stekerdozen 1 polig - universeel
-  Sockets 1 pin - universal
-  Universal Steckdosen 1 Polig
-  Prises à 1 pôle - universel

DIN / ISO 4165



IP67



Incl. pakking en gegolfdeprijs aansluiting en deksel



SD.466

V 12 - 24 V W 16 A

 12 mm - L 69 mm

vpe 1

SD.015

V 12 - 24 V W 16 A

 12 mm / 31.5 x 61.5 mm

vpe 1

SD.031

V 6 - 24 V W 12 A

 12 mm





vpe 1

SD.032

V 6 - 50 V W 12 A

 10 mm

vpe 1

-  Stekerdozen 1 polig - universeel opbouw
-  Sockets 1 pin - universal build up
-  Universal Steckdosen 1 Polig Aufbau
-  Prises à 1 pôle - universel

DIN / ISO 4165



SD.029

V 6 - 12 V W 12 A

 12 mm

vpe 1







SD.030

V 6 - 12 V W 12 A

 12 mm

vpe 1

-  Stekersdozen 3 polig - universeel
-  Sockets 3 pin - universal
-  Universal Steckdosen 3 Polig
-  Prises à 3 pôles - universel

DIN / ISO 4165





SD.021

V 12 - 24 V W 16 A

 34.0 x 94.0 mm

vpe 1

-  Aansteker - universeel - met verlichting
-  Cigarette lighter - universal - illuminated
-  Zigarettenanzünder - Universal - mit Beleuchtung
-  Allumeur - universel - avec éclairage







SD.022

V 12 V W 10 A

 27.8 - 21.85 mm

 max. 1.5 mm<sup>2</sup>

vpe 1

-  Verlengkabel / Adapters - universeel
-  Extension cable / adapters - universal
-  Verlängerungskabel / Adapter - Universal
-  Câble prolongateur / adaptateur - universel

DIN / ISO 4165



SD.467

V 12 - 24 V W 16 A

 20.95 mm

vpe 1

SD.023

V 12 - 24 V W 8 A

 0.25 mtr.  2 x 0.75 mm<sup>2</sup>





vpe 1

SD.024

V 12 - 24 V W 16 A

 0.25 mtr.  2 x 0.75 mm<sup>2</sup>

vpe 1

-  Verlengkabel / Adapters - universeel
-  Extension cable / adapters - universal
-  Verlängerungskabel / Adapter- Universal
-  Câble prolongateur / adaptateur - universel

DIN / ISO 4165



SD.025

**V** 12 - 24 V **W** 16 A  
 0.25 mtr. 2 x 0.75 mm<sup>2</sup>  
 vpe 1



SD.026

**V** 12 - 24 V **W** 8 A  
 0.60 mtr.- 3.00 mtr 2 x 0.75 mm<sup>2</sup>  
 vpe 1







SD.027





**V** 12 - 24 V **W** 8 A  
 4.00 mtr. 2 x 0.75 mm<sup>2</sup>  
 vpe 1



SD.028

**V** 12 - 24 V **W** 16A  
 4.00 mtr. 2 x 0.75 mm<sup>2</sup>  
 vpe 1

-  Steker + Oplaadkabel met mini USB stekker
-  Plug + Charging cable with mini USB plug
-  Stecker + Ladekabel mit Mini USB Stecker
-  Fiche + câble chargeur avec fiche mini USB

-  Stekker + Oplaadkabel met: mini USB stekker
-  Plug + Charging cable with: mini USB plug
-  Stecker + Ladekabel mit Mini: USB Stecker
-  Fiche + Câble chargeur avec: fiche mini USB







SD.424

**V** Input 12 - 24 V **A** output 5 V 2000 Ma  
 1.50 mtr. 2 x 0.75 mm<sup>2</sup>  
 vpe 1



SD.425

**V** Input 12 - 24 V **A** output 5 V 2000 Ma  
 1.50 mtr. 2 x 0.75 mm<sup>2</sup>  
 vpe 1

-  Steker + Oplaadkabel met USB stekker
-  Plug + Charging cable with USB plug
-  Stecker + Ladekabel mit Mini USB Stecker
-  Fiche + câble chargeur avec fiche USB

-  Oplaadkabel met USB stekker
-  Charging cable with USB plug
-  Ladekabel mit Mini USB Stecker
-  Câble chargeur avec fiche USB

SD.453

**V** Input 12 - 24 V  
**V** output 5 V  
**A** 2000 Ma  
 1.50 mtr.  
 2 x 0.75 mm<sup>2</sup>  
 vpe 1



SD.452

**V** Input 12 - 24 V  
**V** output 5 V  
**A** 2000 Ma  
 1.50 mtr.  
 2 x 0.75 mm<sup>2</sup>  
 vpe 1



-  **Stekers / Stekerdozen 1 polig**
-  **Plugs / Sockets 1 pin**
-  **Stecker / Steckdosen 1 Polig**
-  **Fiches / Prises à 1 pôle**



**SD.035**

**V** 24 V  
**A** 300 A  
 35 mm<sup>2</sup>  
 vpe 1

**SD.036**





**V** 24 V  
**A** 300 A  
 35 mm<sup>2</sup>  
 vpe 1

**SD.037**

**V** 24 V  
**A** 300 A  
 35 mm<sup>2</sup>  
 vpe 1

**SD.038**

**V** 24 V  
**A** 300 A  
 35 mm<sup>2</sup>  
 vpe 1

-  **Stekers / dozen - rubber - met randaarde**
-  **Sockets / plugs - rubber**
-  **Stecker / Kupplungen - Vollgummi**
-  **Fiches / Prises - à caoutchouc**

IP 44  
 DIN 49440/441

**SD.007**

**V** 250 V  
**A** 10 A - 16 A  
 3 x 1.5 mm<sup>2</sup>  
 vpe 1



**SD.008**

**V** 250 V  
**A** 10 A - 16 A  
 3 x 1.5 mm<sup>2</sup>  
 vpe 1



-  **Stekers / Stekerdozen 2 polig**
-  **Plugs / Sockets 2 pins**
-  **Stecker / Steckdosen 2 Polig**
-  **Fiches / Prises à 2 pôles**

C DIN / ISO 14690



**SD.009**

3 x 1.5 mm<sup>2</sup>  
**V** 6 - 42 V  
**A** 30 A  
 1.0 - 3.0 mm<sup>2</sup>  
 80 mm  
 vpe 1



**SD.010**

**V** 6 - 42 V  
**A** 30 A  
 1.0 - 3.0 mm<sup>2</sup>  
 68 mm  
 vpe 1



**SD.033**

**V** 6 - 42 V  
**A** 30 A  
 1.0 - 3.0 mm<sup>2</sup>  
 94 mm  
 vpe 1



**SD.034**

**V** 6 - 42 V  
**A** 30 A  
 1.0 - 3.0 mm<sup>2</sup>  
 85 mm  
 vpe 1



- Stekers 2 polig - met soldeer/crimp contacten
- Plugs 2 pins - with crimp/soldering contacts
- Stecker 2 Polig - mit Crimp/Lötkontakten
- Fiches à 2 pôles - avec contacts à sertir/souder

VG 96 917

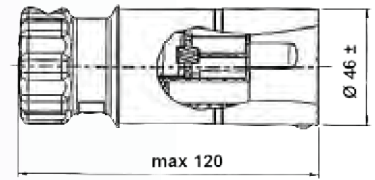

SD.400



SD.426



SD.427



SD.428

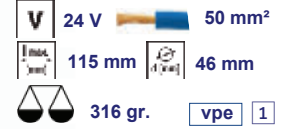

- Stekers 2 polig - met soldeer/crimp contacten
- Plugs 2 pins - with crimp/soldering contacts
- Stecker 2 Polig - mit Crimp/Lötkontakten
- Fiches à 2 pôles - avec contacts à sertir/souder

VG 96 917

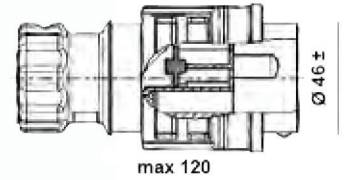

VG 96917 E001A



SD.417



VG 96917 E001B



SD.401



SD.429



SD.210

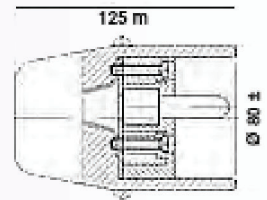

- Contactstift voor Stekers 2 polig
- Contact pin for Plugs 2 pins
- Kontaktstift für Stecker 2 Polig
- Plot de contact Fiches à 2 pôles



SD.404 35 mm²

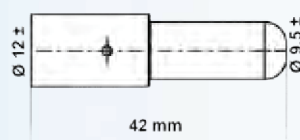
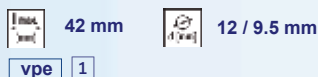

SD.404-50 50 mm²

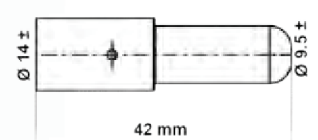

- Stekerdozen 2 polig - met soldeer/crimp contacten
- Sockets 2 pins - with crimp/soldering contacts
- Steckdosen 2 Polig - mit Crimp/Lötkontakten
- Prises à 2 pôles - avec contacts à sertir/souder

VG 96 917

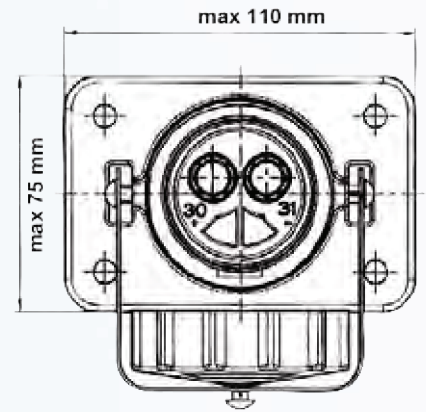

Rubber coating

Rubber coating

SD.402

24 V 35-50 mm<sup>2</sup>  
 110 mm 80.9 mm  
 410 gr. vpe 1

SD.407

24 V 35 mm<sup>2</sup>  
 110 mm 80.9 mm  
 432 gr. vpe 1

SD.430

24 V 50 mm<sup>2</sup>  
 110 mm 80.9 mm  
 432 gr. vpe 1



SD.406

24 V 70 mm<sup>2</sup>  
 155 mm 69 / 105 mm  
 998 gr. vpe 1

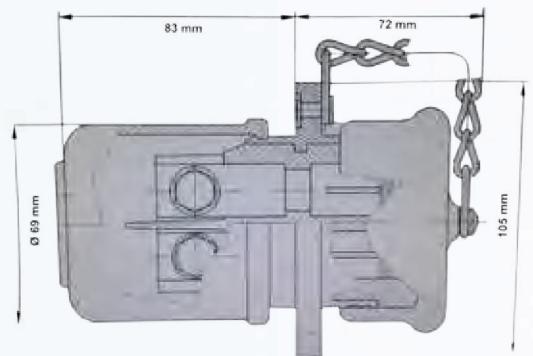

Kabelaansluiting M10

- Contactbus voor Dozen 2 polig
- Contact socket for Sockets 2 pins
- Kontaktbuchse für Steckdosen 2 Polig
- Plot de contact Prises à 2 pôles

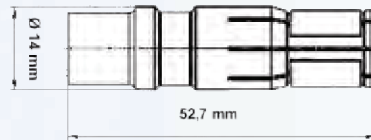

SD.405

35-50 mm<sup>2</sup>  
 52.7 mm  
 14 mm  
 vpe 1

- Koppelingen zonder/met schroefkappen - rubber
- Coupler without/with screw caps - rubber
- Kupplung ohne/mit Schraubkappen - Gummi
- Raccords sans/avec capuchon fileté - en caoutchouc



SD.403

24 V 35 mm<sup>2</sup>  
 63 mm 41.5 mm  
 vpe 1

SD.409

24 V 70 mm<sup>2</sup>  
 86 mm 67 mm  
 vpe 1

SD.410

24 V 35 mm<sup>2</sup>  
 103 mm 76 mm  
 vpe 1

SD.408

24 V 70 mm<sup>2</sup>  
 103 mm 76 mm  
 vpe 1

-  Stekers / Stekerdozen 2 polig - met crimp/soldeer contacten - polycarbonaat
-  Plugs 2 pins - with crimp/soldering - polycarbonate
-  Stecker 2 Polig - mit Crimp/Lötkontakten - Polykarbonat
-  Fiche / Prises à 2 pôles - avec contacts à sertir/souder - polycarbonate

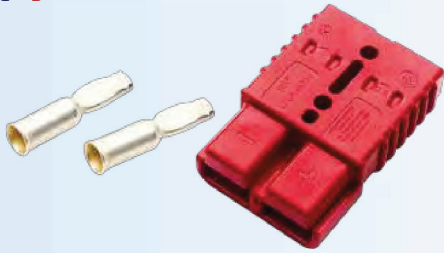

SD.434  6 - 16 mm<sup>2</sup>

**V** max. 600 V **A** 50 A  
 dim. 47.6 x 36.5 x 16 mm  13.3 mm<sup>2</sup>  
 vpe 1

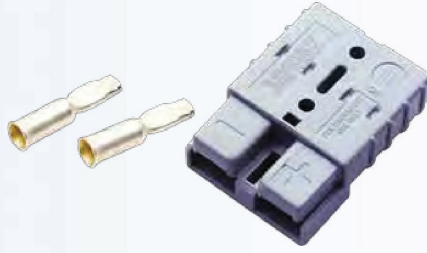

SD.435  6 - 16 mm<sup>2</sup>

**V** max. 600 V **A** 50 A  
 dim. 47.6 x 36.5 x 16 mm  13.3 mm<sup>2</sup>  
 vpe 1



SD.436  6 - 16 mm<sup>2</sup>

**V** max. 600 V **A** 50 A  
 dim. 47.6 x 36.5 x 16 mm  13.3 mm<sup>2</sup>  
 vpe 1



SD.443  
 handvat - handle  
 handgriff - poignée

vpe 1



SD.444  
 stofkap- dust cover  
 Staubschutzabdeckung  
 bouchon anti-poussière

vpe 1



SD.449

contact

vpe 1

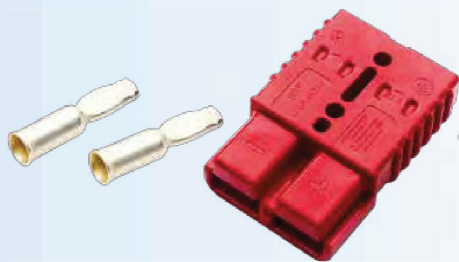

SD.437  25 - 35 mm<sup>2</sup>

**V** max. 600 V **A** 175 A  
 dim. 79.4 x 55.6 x 26 mm  53.5 mm<sup>2</sup>  
 vpe 1

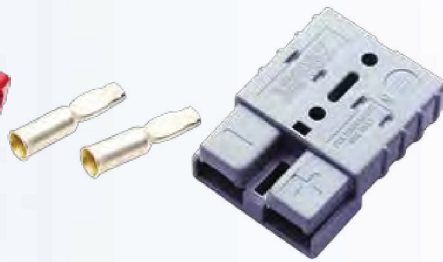

SD.438  25 - 35 mm<sup>2</sup>

**V** max. 600 V **A** 175 A  
 dim. 79.4 x 55.6 x 26 mm  53.5 mm<sup>2</sup>  
 vpe 1

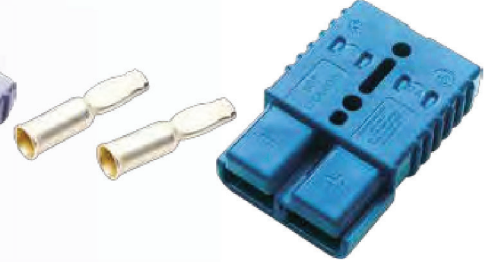

SD.439  25 - 35 mm<sup>2</sup>

**V** max. 600 V **A** 175 A  
 dim. 79.4 x 55.6 x 26 mm  53.5 mm<sup>2</sup>  
 vpe 1



SD.445  
 handvat - handle  
 handgriff - poignée

vpe 1



SD.446  
 stofkap- dust cover  
 Staubschutzabdeckung  
 bouchon anti-poussière

vpe 1







SD.450 contact vpe 1



SD.473  
 trekontlasting - strain relief  
 Zugentlastung - soulagement de la tension

vpe 1



-  Stekers / Stekerdozen 2 polig - met crimp/soldeer contacten - polycarbonaat
-  Plugs 2 pins - with crimp/soldering - polycarbonate
-  Stecker 2 Polig - mit Crimp/Lötkontakten - Polykarbonat
-  Fiche / Prises à 2 pôles - avec contacts à sertir/souder - polycarbonate

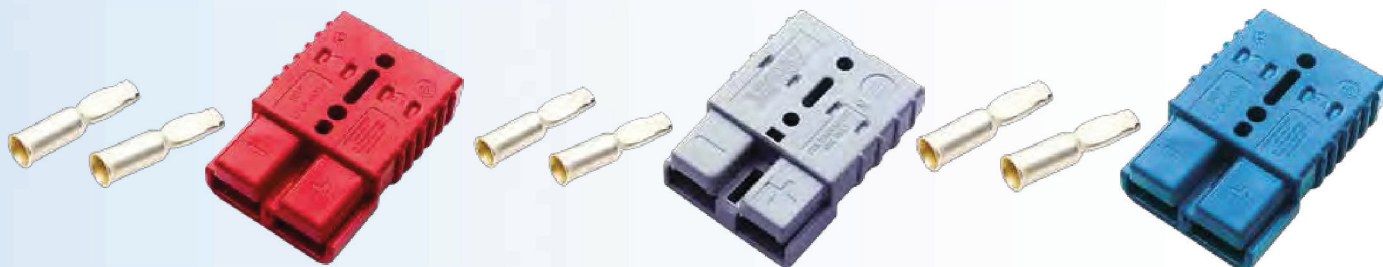

SD.440  50 - 70 mm<sup>2</sup>

**V** max. 600 V **A** 300 A

dim. 108 x 69.8 x 26 mm  67.4 mm<sup>2</sup>

vpe 1

SD.441  50 - 70 mm<sup>2</sup>

**V** max. 600 V **A** 300A

dim. 108 x 69.8 x 26 mm  67.4 mm<sup>2</sup>

vpe 1

SD.442  50 - 70 mm<sup>2</sup>

**V** max. 600 V **A** 300 A

dim. 108 x 69.8 x 26 mm  67.4 mm<sup>2</sup>

vpe 1



SD.447

handvat - handle  
handgriff - poignée

vpe 1

SD.448

stofkap- dust cover  
Staubschutzabdeckung  
bouchon anti-poussière

vpe 1

SD.451

contact



vpe 1

SD.472  50 - 70 mm<sup>2</sup>

**V** max. 600 V **A** 350 A

dim. 108 x 69.8 x 26 mm  67.4 mm<sup>2</sup>

vpe 1

-  Stekers / Stekerdozen 2 polig - met soldeer contacten
-  Plugs / Sockets 2 pins - with soldering contacts
-  Stecker / Steckdosen 2 Polig - mit Lötkontakten
-  Fiche / Prises à 2 pôles - avec contacts à souder

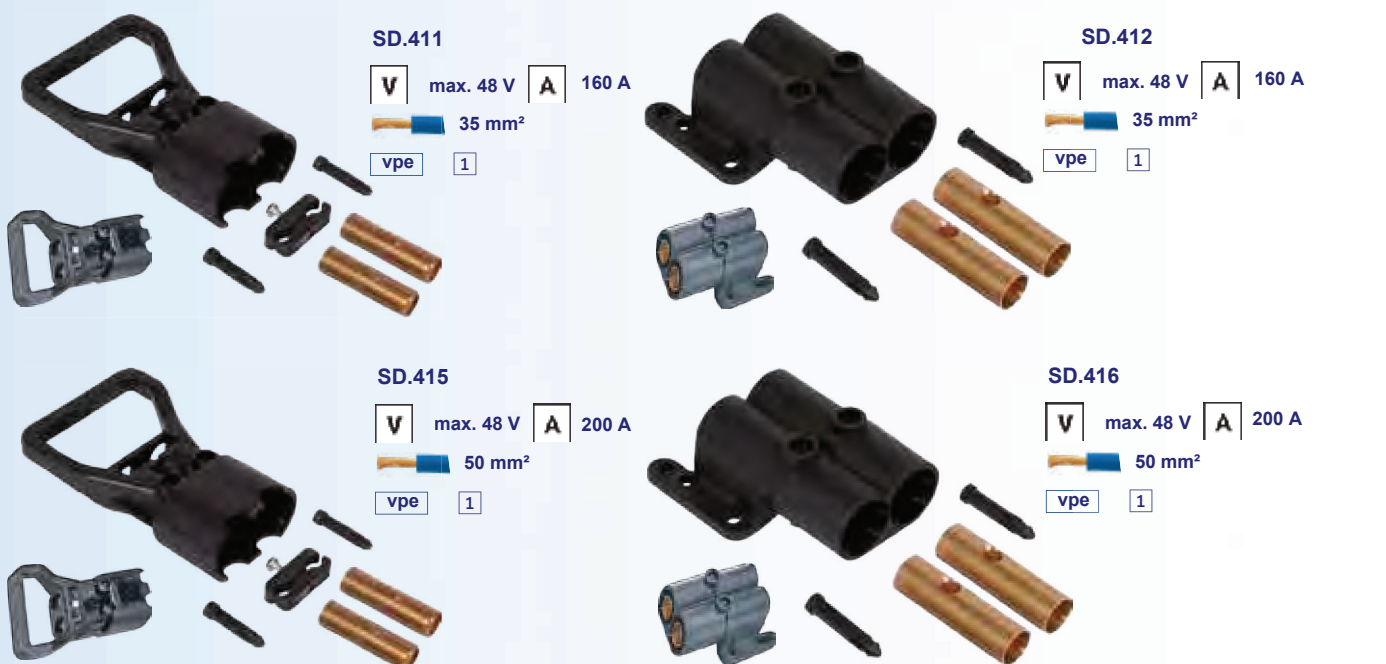

SD.411

**V** max. 48 V **A** 160 A

 35 mm<sup>2</sup>

vpe 1

SD.412

**V** max. 48 V **A** 160 A

 35 mm<sup>2</sup>

vpe 1

SD.415

**V** max. 48 V **A** 200 A

 50 mm<sup>2</sup>

vpe 1



SD.416

**V** max. 48 V **A** 200 A

 50 mm<sup>2</sup>

vpe 1

contacten separaat leverbaar op aanvraag





-  Stekers / Stekerdozen 2 polig - met soldeer contacten
-  Plugs / Sockets 2 pins - with soldering contacts
-  Stecker / Steckdosen 2 Polig - mit Lötkontakten
-  Fiche / Prises à 2 pôles - avec contacts à souder



**SD.419**  
**V** max. 48 V **A** 80 A  
 35 mm<sup>2</sup>  
 vpe 1



**SD.420**  
**V** max. 48 V **A** 80 A  
 35 mm<sup>2</sup>  
 vpe 1

-  Stekers / Stekerdozen 2 polig - met crimp contacten
-  Plugs 2 pins - with crimp contacts
-  Stecker 2 Polig - mit Crimpkontakten
-  Fiche / Prises à 2 pôles - avec contacts à sertir/



contacten separaat leverbaar op aanvraag



**SD.413**  
**V** max. 48 V **A** 160 A  
 35 mm<sup>2</sup>  
 vpe 1  
 Crimp



**SD.414**  
**V** max. 48 V **A** 160 A  
 35 mm<sup>2</sup>  
 vpe 1  
 Crimp

-  Stekers / Stekerdozen 3 polig DIN / ISO 14 690
-  Plugs / Sockets 3 pins DIN / ISO 9680
-  Stecker / Steckdosen 3 Polig
-  Fiches / Prises à 3 pôles



**SD.115** vpe 1  
**V** 6 - 12 - 24 V  
**A** 1.5mm<sup>2</sup> 16 A  
 2.5mm<sup>2</sup> 25 A



**SD.114** vpe 1  
**V** 6 - 12 - 24 V  
**A** 1.5mm<sup>2</sup> 16 A  
 2.5mm<sup>2</sup> 25 A



**SD.111** vpe 1  
**V** 6 - 12 - 24 V  
**A** 1.5mm<sup>2</sup> 16 A  
 2.5mm<sup>2</sup> 25 A







**SD.110** vpe 1  
**V** 6 - 12 - 24 V  
**A** 1.5mm<sup>2</sup> 16 A  
 2.5mm<sup>2</sup> 25 A



**SD.6870**  
**V** max. 48 V **A** 5 A  
 3 x 1.5 mm<sup>2</sup>  
 vpe 1



**SD.6871**  
**V** max. 48 V **A** 5 A  
 3 x 1.5 mm<sup>2</sup>  
 vpe 1

-  **Stekers 7 polig - kunststof / aluminium - trekontlasting**
-  **Plugs - 7 pins - synthetic material / aluminium - pull relief**
-  **Stecker - 7 Polig - Kunststoff / Aluminium - mit Zugentlastung**
-  **Fiches - à 7 pôles - matière en plastique / aluminium - avec serre câble**

ISO 1724

12 V



SD.101 vpe 1

**V** 6 - 12 V

**A** 1.5mm<sup>2</sup> 16 A  
2.5mm<sup>2</sup> 25 A



SD.105 vpe 1

**V** 6 - 12 V





**A** 1.5mm<sup>2</sup> 16 A  
2.5mm<sup>2</sup> 25 A



SD.106 vpe 1

**V** 6 - 12 V

**A** 1.5mm<sup>2</sup> 16 A  
2.5mm<sup>2</sup> 25 A

-  **Stekerdozen 7 polig - slagvast - trekontlasting - uitneembaar interieur - mistlamp uitschakelcontact** ISO 1724
-  **Sockets 7 pins - impact resistant - pull relief - removable interior - switch-off for rear fog light** 6 - 12 V
-  **Steckdosen 7 Polig - Schlagfest - mit Zugentlastung - Einsatz ausnehmbar - Abschaltkontakt für Nebelschlussleuchte**
-  **Prises à 7 pôles - résistant aux chocs - avec serre câble - insert détachable - avec rupture pour feu arrière antibrouillard**



SD.108

**V** 6 - 12 V

**A** 1.5mm<sup>2</sup> 16 A  
2.5mm<sup>2</sup> 25 A

**mat.** PVC 

**vpe** 1



SD.104





**V** 6 - 12 V 

**A** 1.5mm<sup>2</sup> 16 A  
2.5mm<sup>2</sup> 25 A

**mat.** Aluminium

**vpe** 1

standaard geleverd zonder tule

-  **Stekerdozen 7 polig - slagvast - trekontlasting - uitneembaar interieur** ISO 1724
-  **Sockets 7 pins - impact resistant - pull relief - removable interior** 6 - 12 V
-  **Steckdosen 7 Polig - Schlagfest - mit Zugentlastung - Einsatz ausnehmbar**
-  **Prises à 7 pôles - résistant aux chocs - avec serre câble - insert détachable**



SD.107

**V** 6 - 12 V

**A** 1.5mm<sup>2</sup> 16 A  
2.5mm<sup>2</sup> 25 A

**mat.** PVC 

**vpe** 1



SD.103



**V** 6 - 12 V 

**A** 1.5mm<sup>2</sup> 16 A  
2.5mm<sup>2</sup> 25 A

**mat.** Aluminium

**vpe** 1

standaard geleverd zonder tule

-  **Koppelingdoos 7 polig** ISO 1724
-  **Coupling socket 7 pins** 6 - 12 V 
-  **Kupplungsdose 7 polig**
-  **Prise d'accouplement à 7 pôles**



SD.102

**V** 6 - 12 V

**A** 1.5mm<sup>2</sup> 16 A  
2.5mm<sup>2</sup> 25 A

**mat.** PVC 

**vpe** 1

- WeSt steekverbinding systeem - stekers 7-/13 polig - NEN 6120
- WeSt plug system - plugs 7-/13 pins - NEN 6120
- WeSt Steckverbindungen - Stecker 7-/13 polig - NEN 6120
- WeSt système de connexion - prises à 7-/13 pôles - NEN 6120

ISO 1724  
 ISO 11446  
 12 V **mat.** PP



- WeSt steekverbinding systeem - stekerdozen 7-/13 polig - incl. afdichting - micro switch voor mistachterlicht - NEN 6120
- WeSt plug system - sockets 7-/13 pins - incl. rubber seal - micro switch for rear fog light - NEN 6120
- WeSt Steckverbindungen - SteckDosen 7-/13 polig - inkl. Gummidichtung - Mikroschaltung für neblschlusssleuchte - NEN 6120
- WeSt système de connexion - fiches à 7-/13 pôles - incl. joint caoutchouc - Micro-interrupteur pour feu arrière anti-brouillard - NEN 6120







DIN/ISO 1724  
 DIN/ISO 11446  
 12 V

- Stekers 13 polig
  - Plugs 13 pins
  - Stecker 13 polig
  - Prises à 13 pôles
- DIN/ISO 11446  
 12 V

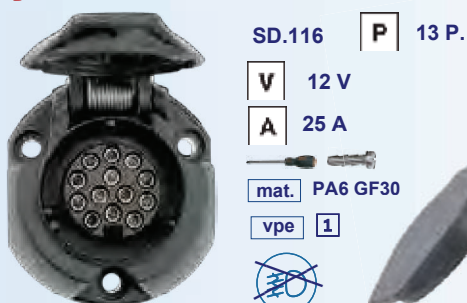

- Stekerdozen 13 polig - incl. afdichting
- Sockets 13 pins - incl. rubber seal
- Steckdosen 13 polig - inkl. Gummidichtung
- Fiches à 13 pôles - incl. joint caoutchouc
- Koppelingdoos 13 polig
- Coupling socket 13 pins
- Kupplungsdose 13 polig
- Prise d'accouplement à 13p
- Parkeerdoos ISO 11446
- Parking socket according ISO 11446
- Parksteckdose nach ISO 11446
- Prise de stationnement selon ISO 11446



-  Stekerdozen 13 polig - incl. afdichting - micro switch voor mistachterlicht
-  Sockets 13 pins - incl. rubber seal - micro switch for rear fog light
-  Steckdosen 13 polig - inkl. Gummidichtung - Mikroschaltung für neblschlussleuchte
-  Fiches à 13 pôles - incl. joint caoutchouc - Micro-interrupteur pour feu arrière anti-brouillard

DIN/ISO 11446

12 V



SD.112 **P** 13 P.

SD.113 **P** 13 P.

SD.141 **P** 13 P.

**V** 12 V   
**A** 25 A Hoogte 50 mm

**V** 12 V   
**A** 25 A Hoogte 50 mm

**V** 12 V   
**A** 25 A Hoogte 50 mm



mat. PA6 GF30 Made in Germany  
vpe 1

mat. PA6 GF30 Made in Germany  
vpe 100

mat. PA6 GF30 Made in PRC  
vpe 1



Uitgang Midden



Uitgang Rechts



SD.137 **P** 13 P.

SD.138 **P** 13 P.

**V** 12 V Hoogte 40 mm  
**A** 25 A

**V** 12 V Hoogte 40 mm  
**A** 25 A

mat. PA6 GF30 Made in Germany  
vpe 1

mat. PA6 GF30 Made in Germany  
vpe 1

-  Stekerdozen 13 polig - incl. afdichting - met 2 micro switch voor mistachterlicht
-  Sockets 13 pins - incl. rubber seal - with 2 micro switch for rear fog light
-  Steckdosen 13 polig - inkl. Gummidichtung - mit 2 Mikroschalter für neblschlussleuchte
-  Fiches à 13 pôles - incl. joint caoutchouc - avec 2 Micro-interrupteur pour feu arrière anti-brouillard



DIN/ISO 11446

12 V







SD.144 **P** 13 P.

**V** 12 V   
**A** 25 A

mat. PA6 GF30 Made in Germany  
vpe 1

De 2e micro switch kan universeel gebruikt worden. Wordt vaak gebruikt voor het uitschakelen van de Park Distance Control (PDC)



-  Afdichtingen voor stekkerdozen
-  Coupling plug 7 pins
-  Gummidichtungen für Steckdosen
-  Joint d'étanchéité en caoutchouc pour prises



SD.109  
1724/3732  
vpe 10



SD.119  
1724/11446  
vpe 10



SD.136  
1724/11446  
vpe 1



SD.432  
11446 - 40 mm  
vpe 10



Adapters - Mini / Compact voor 7-/ 13 polig - 13 / 7 polig - 13 / 13 polig  
 Adapter - Mini / Compact for plugconnectors 7- / 13 pins - 13 / 7 pins - 13 / 13 pins  
 Adapter - Mini / Kompakt für Steckverbindungen 7- / 13 polig - 13 / 7 polig - 13 / 13 polig  
 Adaptateur - Mini/Compact pour connecteurs à 7- / 13 pôles - 13 / 7 pôles - 13 / 13 pôles



Mini

Made in Germany

SD.132 13 P - ISO 11446 7 P - ISO 1724  
 12 V 20 A 52.8 mm  
 vpe mat. PA6 GF30



Mini

Made in Germany

SD.133 13 P - ISO 11446 7 P - ISO 1724  
 12 V 20 A 52.8 mm  
 vpe mat. PA6 GF30



Mini

Made in PRC

SD.142 13 P - ISO 11446 7 P - ISO 1724  
 12 V 20 A 52.8 mm  
 vpe mat. PA6



Made in Germany

SD.122 13 P - ISO 11446 7 P - ISO 1724  
 12 V 20 A 106.4 mm  
 vpe mat. PA6 GF30



Mini

Made in Germany

SD.135 7 P - ISO 1724 13 P - ISO 11446  
 12 V 20 A 52.8 mm  
 vpe mat. PA6 GF30



Mini

Made in PRC

SD.143 7 P - ISO 1724 13 P - ISO 11446  
 12 V 20 A 52.8 mm  
 vpe mat. PA6



Made in Germany

SD.120 13 P - ISO 11446 7 P - ISO 1724 / West 7/13  
 12 V 20 A 52.8 mm  
 vpe mat. PA6 GF30



Mini

Made in Germany

SD.120/IND 13 P - ISO 11446 7 P - ISO 1724 / West 7/13  
 12 V 20 A 52.8 mm  
 vpe mat. PA6 GF30







Made in Germany

SD.121 13 P - ISO 11446 7 P - ISO 1724 / West 7/13  
 12 V 20 A 106.4 mm  
 vpe mat. PA6 GF30







SD.121/IND 13 P - ISO 11446 7 P - ISO 1724 / West 7/13  
 12 V 20 A 106.4 mm  
 vpe mat. PA6 GF30





Made in Germany

-  Adapters - kabeluitvoering - voor 7-/ 13 polig - 13 / 7 polig - 13 / 13 polig
-  Adapter - cable type - for plugconnectors 7-/ 13 pins - 13 / 7 pins - 13 / 13 pins
-  Adapter - Kabeladapter für Steckverbindungen 7-/ 13 polig - 13 / 7 polig - 13 / 13 polig
-  Adaptateur - à câble pour connecteurs à 7-/ 13 pôles - 13 / 7 pôles - 13 / 13 pôles







**SD.123**  13 P - ISO 11446  
 12 V  7 P - ISO 1724  
 20 A  700 mm  
 vpe 1 mat. PA6 GF30 - PVC







**SD.124**  7 P - ISO 1724  
 12 V  13 P - ISO 11446  
 20 A  700 mm  
 vpe 1 mat. PA6 GF30 - PVC



**SD.126**  13 P - ISO 11446  
 12 V  7 P - ISO 1724 / West  
 20 A  7/13 700 mm  
 vpe 1 mat. PA6 GF30 - PVC



**SD.134**  7 P - ISO 1724 / West  
 12 V  7/13 13 P - ISO 11446  
 20 A  700 mm  
 vpe 1 mat. PA6 GF30 - PVC

-  Adapters - Omvormers
-  Adapter - Converters
-  Adapter - Spannungswandler
-  Adaptateur - Convertisseur

24V DC > 12V DC



**SD.150** vpe 1  
 Ingangsspanning: 24 V  
 Aantal polen (ingang): 7-polig DIN:1724 N  
 Uitgangsspanning: 12 V  
 Aantal polen (Uitgang): 7-polig DIN:1724 N  
 Nominaal vermogen 6 x 70 W  
 Diameter / Lengte 74 mm / 191 mm



**SD.151** vpe 1  
 Ingangsspanning: 24 V  
 Aantal polen (ingang): 7-polig DIN:1724 N  
 Uitgangsspanning: 12 V  
 Aantal polen (Uitgang): 13-polig DIN:11446  
 Nominaal vermogen 6 x 70 W  
 Diameter / Lengte 70 mm / 191 mm



**SD.152** vpe 1  
 Ingangsspanning: 24 V  
 Aantal polen (ingang): 7-polig DIN:1185 N  
 Uitgangsspanning: 12 V  
 Aantal polen (Uitgang): 13-polig DIN:11446  
 Nominaal vermogen 6 x 70 W  
 Diameter / Lengte 75 mm / 200 mm

-  **Adapters - Omvormers**
-  **Adapter - Converters**
-  **Adapter - Spannungswandler**
-  **Adaptateur - Convertisseur**

24V DC > 12V DC



SD.153 vpe 1

Ingangsspanning: 24 V  
 Aantal polen (ingang): 15-polig DIN:12098  
 Uitgangsspanning: 12 V  
 Aantal polen (Uitgang): 7-polig DIN:1724 N  
 Nominaal vermogen 7 x 70 W  
 Diameter / Lengte 75 mm / 175 mm







SD.154 vpe 1

Ingangsspanning: 24 V  
 Aantal polen (ingang): 7-polig DIN:1185 N  
 Uitgangsspanning: 12 V  
 Aantal polen (Uitgang): 7-polig DIN:1724 N  
 Nominaal vermogen 6 x 70 W  
 Diameter / Lengte 75 mm / 185 mm



SD.155 vpe 1

Ingangsspanning: 24 V  
 Aantal polen (ingang): 15-polig DIN:12098  
 Uitgangsspanning: 12 V  
 Aantal polen (Uitgang): 13-polig DIN:11446  
 Nominaal vermogen 7 x 70 W  
 Diameter / Lengte 75 mm / 200 mm

-  **Verlengkabels 12V**
-  **Extension cables 12V**
-  **Verlängerungskabel 12V**
-  **Câbles d'extension 12V**

SD.339 vpe 1



Electrospiraal / verlengkabel met 2 x 13-polige Jeager stekker.  
 Werk lengte 3.5 mtr

SD.331 vpe 1



Electrospiraal / verlengkabel met 1 x 13-polige Jeager stekker  
 + 1 x 13 polige zwevende stekkerdoos. Werk lengte 3.5 mtr

SD.337 vpe 1

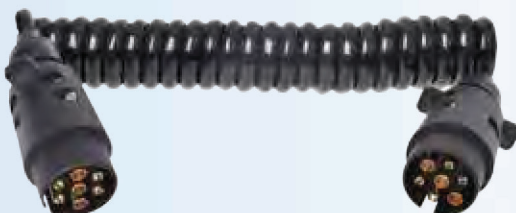





Electrospiraal / verlengkabel met 2 x 7-polige kunststof stekker.  
 Werk lengte 3.5 mtr

SD.338 vpe 1



Electrospiraal / verlengkabel met 2 x 7-polige kunststof stekker.  
 Werk lengte 3.5 mtr







-  Set 7 polig universeel "EURO" - voorgemonteerd, additioneel voorzien van mistachterlichtaansluiting - kunststof stekerdoos - slagvast
-  Set of electric components universal 7 pins "EURO" - assembled with switch off for fog light - impact resistant synthetic socket
-  Universal E-Satz 7 polig - Kunststoff Steckdose "EURO" - montiert mit zusätzlich Abschaltung für Nebelschlussleuchte - Schlagfest
-  Faisceaux électriques universel à 7 pôles "EURO" - socle à matière en plastique - résistant aux impacts - additionè avec coupure anti-brouillard





-  Set 13 polig universeel ISO 11446 - voorgemonteerd, voorzien van mistachterlichtaansluiting - kunststof stekerdoos - slagvast
-  Set of electric components universal 13 pins ISO 11446 assembled with switch off for fog light - impact resistant synthetic socket
-  Universal E-Satz 13 polig - Kunststoff Steckdose ISO 11446 - montiert, mit Abschaltung für Nebelschlussleuchte - Schlagfest
-  Faisceaux électriques universel à 13 pôles ISO 11446 - socle à matière en plastique - résistant aux impacts - avec coupure anti-brouillard

-  Set 13 polig universeel ISO 11446 - voorgemonteerd, voorzien van mistachterlichtaansluiting - kunststof stekerdoos - slagvast
-  Set of electric components universal 13 pins ISO 11446 assembled with switch off for fog light - impact resistant synthetic socket
-  Universal E-Satz 13 polig - Kunststoff Steckdose ISO 11446 - montiert, mit Abschaltung für Nebelschlussleuchte - Schlagfest
-  Faisceaux électriques universel à 13 pôles ISO 11446 - socle à matière en plastique - résistant aux impacts - avec coupure anti-brouillard



-  Set 7-/13 polig universeel "WeSt" - voorgemonteerd, voorzien van mistachterlichtaansluiting - kunststof stekerdoos - slagvast
-  Set of electric components universal 7-/13 pins "WeSt" assembled with switch off for fog light - impact resistant synthetic socket
-  Universal E-Satz 7-/13 polig - Kunststoff Steckdose "WeSt" - montiert, mit Abschaltung für Nebelschlussleuchte - Schlagfest
-  Faisceaux électriques universel à 7-/13 pôles "WeSt" - socle à matière en plastique - résistant aux impacts - avec coupure anti-brouillard

-  Set 13 polig universeel ISO 11446 - voorgemonteerd, met module voor mistachterlichtonderbreking en PDC uitschakeling - kunststof stekerdoos - slagvast
-  Set of electric components universal 13 pins ISO 11446 - with module with fog light interruption and PDC elimination impact resistant synthetic socket
-  Universal E-Satz 13 polig - ISO 11446 - mit Module mit NSL unterbrechung und PDC Abschaltung - Kunststoff Steckdose - Schlagfest

-  Faisceaux électriques universel à 13 pôles ISO 11446 - avec module avec débranchement antibrouillard remorque et avec PDC élimination - socle à matière en plastique - résistant aux impacts











 **Trekhaak toebehoren**





 **Accessories for trailer couplings**

 **Zubehör für Anhängerzugvorrichtungen**



 **Accessoires pour attelages**

-  Hulpkoppeling met veer - verzinkt
-  coupling with spring - zinc plated
-  Kupplungsbügel mit Feder - Galvanisiert
-  Accouplement auxiliaire à ressort - galvanisé

-  Hulpkoppeling met gleuf - verzinkt
-  Auxillary coupling with slot - zinc plated
-  Kupplungsbügel mit Schlitz - Galvanisiert
-  Accouplement auxiliaire à gorge - galvanisé

-  Kabel met strip - verzinkt
-  Safety cable with strip - zinc plated
-  Sicherheitskabel + Streif - Galvanisiert
-  Câble de sécurité avec bande - galvanisé







**SD.802**  







**SD.803**  



**SD.804**  

-  Kabel met stekerhouder - verzinkt
-  Security cable + plug holder - zinc plated
-  Sicherheitskabel + Steckerhalter - Galvanisiert
-  Câble de sécurité avec console et support de fiche galvanisé



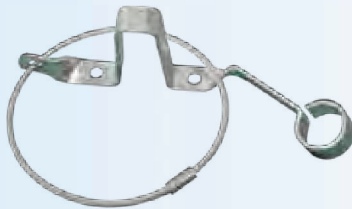

-  Rembrekkabel
-  Brake away safety cable
-  Abreisseil komplett
-  Câble de rupture complet











**SD.806**  



**SD.800**  
 1.00 mtr  
 

-  Kentekenplaathouder - set - roestvrij staal
-  Registration plate holder clamp - set - stainless steel
-  Nummernschildhalter Satz - Rostfrei Stahl
-  Jeu support de plaque d'immatriculation - acier inoxydable

-  Motorkaphaak - set
-  Bonnet fastener - set
-  Motorhaubenverschluss - Satz
-  Jeu crochet pour capot moteur

-  Testapparaat 7-/ 13 polig
-  Sockettester 7-/ 13 polig
-  Prüfgerät für Steckverbindungen 7-/ 13 polig
-  Appareil de contrôle pour fiches à 7-/ 13 pôles

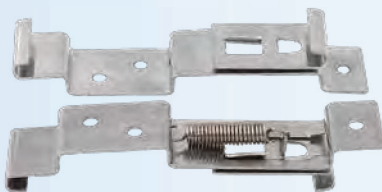

**SD.805**  



**SD.807**  



**SD.199**  
 12 V  
 



- Adapters - toepassing
- Adapter - application
- Adapter - Anwendung
- Adapteur - application



**13p**  
ISO 11446



**SD.112**

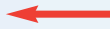

**SD.132**



**SD.101**



**SD.105**



**7p**  
ISO 1724



**13p**  
ISO 11446



**SD.112**

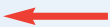

**SD.122**

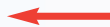

**SD.101**



**SD.105**



**7p**  
ISO 1724



**13p**  
ISO 11446



**SD.112**

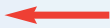

**SD.121**



**SD.130**



**SD.101**



**SD.105**



**7p**  
ISO 1724  
**WeST 7-/13 p**



**13p**  
ISO 11446



**SD.112**

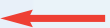

**SD.126**



**SD.130**



**SD.101**



**SD.105**



**7p**  
ISO 1724  
**WeST 7-/13 p**



**13p**  
ISO 1724  
**WeST 7-/13 p**



**SD.112**



**SD.123**



**SD.101**



**SD.105**



**7p**  
ISO 1724



**7p**  
ISO 1724



**SD.108**



**SD.104**

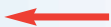

**SD.135**



**SD.117**



**13p**  
ISO 11446



**7p**  
ISO 1724



**SD.108**



**SD.104**



**SD.124**



**SD.117**



**13p**  
ISO 11446



**7p**  
ISO 1724  
**WeST 7-/13 p**



**SD.108**



**SD.104**



**SD.127**

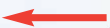

**SD.134**





12-18



**SD.117**



**13p**  
ISO 11446





-  **Stekers 7 polig - kunststof / aluminium - trekontlasting** ISO 1185 - N
-  **Plugs - 7 pins - synthetic material / aluminium - pull relief** ISO 3731 - S
-  **Stecker - 7 Polig - Kunststoff / Aluminium - mit Zugentlastung**
-  **Fiches - à 7 pôles - matière en plastique / aluminium - avec serre câble** 

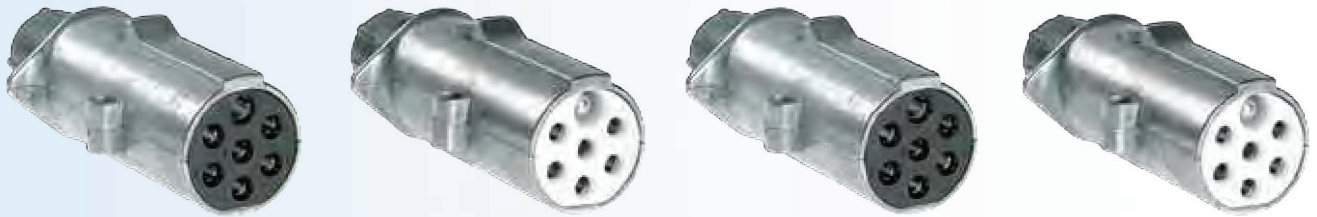





<p>SD.228 <b>type</b> N <b>vpe</b> 1</p> <p><b>V</b> 24 V <b>mat.</b> PA 6.6 Nylon</p> <p><b>A</b> 20 A </p>	<p>SD.229 <b>type</b> S <b>vpe</b> 1</p> <p><b>V</b> 24 V <b>mat.</b> PA 6.6 Nylon</p> <p><b>A</b> 20 A </p>	<p>SD.207 <b>type</b> N <b>vpe</b> 1</p> <p><b>V</b> 24 V <b>mat.</b> GFK</p> <p><b>A</b> 20 A </p>	<p>SD.198 <b>type</b> S <b>vpe</b> 1</p> <p><b>V</b> 24 V <b>mat.</b> GFK</p> <p><b>A</b> 20 A </p>
---	---	---	--







<p>SD.204 <b>type</b> N <b>vpe</b> 1</p> <p><b>V</b> 24 V <b>mat.</b> Aluminium</p> <p><b>A</b> 20 A </p>	<p>SD.214 <b>type</b> S <b>vpe</b> 1</p> <p><b>V</b> 24 V <b>mat.</b> Aluminium</p> <p><b>A</b> 20 A </p>	<p>SD.237 <b>type</b> N <b>vpe</b> 1</p> <p><b>V</b> 24 V <b>mat.</b> Aluminium</p> <p><b>A</b> 20 A </p>	<p>SD.227 <b>type</b> S <b>vpe</b> 1</p> <p><b>V</b> 24 V <b>mat.</b> Aluminium</p> <p><b>A</b> 20 A </p>
--	--	---	--

-  **Stekerdozen 7 polig - kunststof / aluminium - slagvast** ISO 1185 - N
-  **Sockets 7 pins - synthetic material / aluminium - impact resistant** ISO 3731 - S
-  **Steckdosen 7 Polig - Kunststoff / Aluminium - Schlagfest**
-  **Prises à 7 pôles - matière en plastique / aluminium - résistant aux chocs** 



<p>SD.230 <b>type</b> N <b>vpe</b> 1</p> <p><b>V</b> 24 V <b>mat.</b> PA 6.6 Nylon</p> <p><b>A</b> 20 A </p> 	<p>SD.231 <b>type</b> S <b>vpe</b> 1</p> <p><b>V</b> 24 V <b>mat.</b> PA 6.6 Nylon</p> <p><b>A</b> 20 A </p> 
---	--



<p>SD.202 <b>type</b> N <b>vpe</b> 1</p> <p><b>V</b> 24 V <b>mat.</b> Aluminium</p> <p><b>A</b> 20 A </p> 	<p>SD.212 <b>type</b> S <b>vpe</b> 1</p> <p><b>V</b> 24 V <b>mat.</b> Aluminium</p> <p><b>A</b> 20 A </p> 
--	---

-  Stekerdozen 7 polig - kunststof / aluminium - slagvast
-  Sockets 7 pins - synthetic material / aluminium - impact resistant
-  Steckdosen 7 Polig - Kunststoff / Aluminium - Schlagfest
-  Prises à 7 pôles - matière en plastique / aluminium - résistant aux chocs

ISO 1185 - N

ISO 3731 - S



SD.205 type N vpe 1

V 24 V mat. Aluminium  
A 20 A 



SD.200 type N vpe 1

V 24 V mat. Aluminium  
A 20 A 



5x2 + 2x3

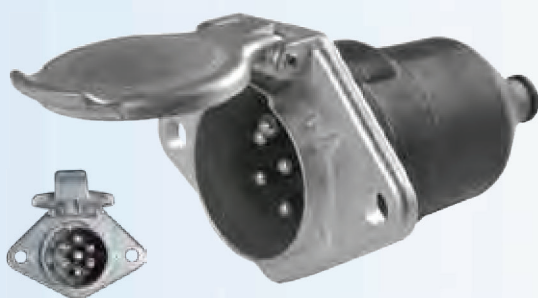





SD.209 type N vpe 1

V 24 V mat. Aluminium  
A 20 A 



SD.203 vpe 1

stofkap - dust cover -  
Staubschutzabdeckung  
bouchon anti-poussière

-  ABS - Steker / Stekerdozen - 5 polig - trekontlasting - kunststof slagvast - ADR/GGVS gekeurd
-  ABS - Plugs / Sockets - 5 pins - pull relief - ADR/GGVS tested - impact resistant synthetic material
-  ABS - Stecker / Steckdosen - 5 polig - Kunststoff schlagfest mit Zugentlastung - ADR/GGVS geprüft
-  ABS - Fiches / Prises à 5 pôles - résistant aux chocs- avec serre câble - matière en plastique - ADR/GGVS contrôle

ISO 7638



SD.215 ABS - 5 p. vpe 1

V 24 V mat. PA 6.6 Nylon  
A 20 A  crimp



SD.216 ABS - 5 p. vpe 1

V 24 V mat. PA 6.6 Nylon  
A 20 A  crimp







SD.454 ABS - 5 p. vpe 1

V 24 V mat. PA 6.6 Nylon  
A 20 A  



SD.455 ABS - 5 p. vpe 1

V 24 V mat. PA 6.6 Nylon  
A 20 A  

-  EBS - Steker / Stekerdozen - 7 polig - trekontlasting - kunststof slagvast - ADR/GGVS gekeurd ISO 7638
-  EBS - Plugs / Sockets - 7 pins - pull relief - ADR/GGVS tested - impact resistant synthetic material 
-  EBS -Stecker / Steckdosen - 7 polig - Kunststoff schlagfest mit Zugentlastung - ADR/GGVS geprüft
-  EBS - Fiches / Prises à 7 pôles - résistant aux chocs- avec serre câble - matière en plastique - ADR/GGVS contrôle





SD.234 EBS - 7p. vpe 1  
V 24 V mat. PA 6.6 Nylon  
A 20 A  crimp









SD.235 EBS - 7p. vpe 1  
V 24 V mat. PA 6.6 Nylon  
A 20 A  crimp



SD.456 EBS - 7p. vpe 1  
V 24 V mat. PA 6.6 Nylon  
A 20 A  



SD.457 EBS - 7p. vpe 1  
V 24 V mat. PA 6.6 Nylon  
A 20 A  

-  ADR/GGVS - Steker / Stekerdozen - 15 polig - trekontlasting - kunststof slagvast - ADR/GGVS gekeurd ISO 12098
-  ADR/GGVS - Plugs / Sockets - 15 pins - pull relief - ADR/GGVS tested - impact resistant synthetic material 
-  ADR/GGVS -Stecker / Steckdosen - 15 polig - Kunststoff schlagfest mit Zugentlastung - ADR/GGVS geprüft
-  ADR/GGVS - Fiches / Prises à 15 pôles - résistant aux chocs- avec serre câble - matière en plastique - ADR/GGVS contrôle





SD.217  
V 24 V  
A 20 A  
 crimp  
mat. PA 6.6 Nylon  
type ADR/GGVS - 15 p.  
vpe 1





SD.218  
V 24 V  
A 20 A  
 crimp  
mat. PA 6.6 Nylon  
type ADR/GGVS - 15 p.  
vpe 1



SD.458  
V 24 V  
A 20 A  
   
mat. PA 6.6 Nylon  
type ADR/GGVS - 15 p.  
vpe 1



SD.459  
V 24 V  
A 20 A  
   
mat. PA 6.6 Nylon  
type ADR/GGVS - 15 p.  
vpe 1

-  Contactbus voor ABS / EBS / ADR-GGVS steker 5 - 7 - 15 polig ISO 7638
-  Contact sleeve for ABS / EBS / ADR-GGVS plug 5 - 7 - 15 pins
-  Kontakthülse für ABS / EBS / ADR-GGVS stecker 5 - 7 - 15 polig
-  Douille de contact ABS / EBS / ADR-GGVS fiche à 5 - 7 - 15 pôles



SD.220  1.0 - 2.5 mm<sup>2</sup> vpe 1  crimp



SD.226  4.0 mm<sup>2</sup> vpe 1  crimp



SD.462  1.0 - 2.5 mm<sup>2</sup> vpe 1  



SD.463  4.0 mm<sup>2</sup> vpe 1  

-  Contactstift voor ABS / EBS / ADR-GGVS stekerdozen 5 - 7 - 15 polig
-  Contact pin for ABS / EBS / ADR-GGVS sockets 5 - 7 - 15 pins
-  Kontaktstift für ABS / EBS / ADR-GGVS Steckdosen 5 - 7 - 15 polig
-  Plot de contact ABS / EBS / ADR-GGVS Prises à 5 - 7 - 15 pôles



SD.470  1.5 - 4.0 mm<sup>2</sup>

 vpe 10



SD.222  1.0 - 2.5 mm<sup>2</sup>

 vpe 1  crimp



SD.225  4.0 mm<sup>2</sup>

 vpe 1  crimp







SD.460  1.0 - 2.5 mm<sup>2</sup>

 vpe 1  crimp



SD.461  4.0 mm<sup>2</sup>

 vpe 1  crimp

-  Afdichting voor contactstift / contactbus ABS / EBS / ADR-GGVS 5 - 7 - 15 polig
-  Seal for contact pin / contact sleeve ABS / EBS / ADR-GGVS 5 - 7 - 15 pins 
-  Abdichtung für kontaktstift / kontakthülse ABS / EBS / ADR-GGVS 5 - 7 - 15 polig
-  Joint d' étanchéité pour plot de contact / douille de contact ABS / EBS / ADR-GGVS à 5 - 7 - 15 pôles



SD.243  1.0 - 2.5 mm<sup>2</sup>

 8.5 mm

 7.9 - 8.2 mm

 vpe 50







SD.242  4.0 mm<sup>2</sup>

 8.5 mm

 7.9 - 8.2 mm

 vpe 50

-  Parkeerdoos voor ABS / EBS / ADR-GGVS steker
-  Parking socket for ABS / EBS / ADR-GGVS plug 
-  Parksteckdose für ABS / EBS / ADR-GGVS stecker
-  Prise de stationnement pour fiche ABS / EBS / ADR-GGVS



SD.219

 vpe 1

-  Nato Steker / Stekerdozen - 12 polig - trekontlasting - roestvrij staal - VG gekeurd
-  Nato Plugs / Sockets - 12 pins - pull relief - VG tested - stainless steel 
-  Nato Stecker / Steckdosen - 12 polig - Rostfrei Stahl - Zugentlastung - VG geprüft
-  Nato Fiches / Prises à 12 pôles - résistant aux chocs - avec serre câble - acier inoxydable - VG contrôle



VG 96 923 L002

SD.248

 24 V



 vpe 1



VG 96 923 A-12S

SD.249

 24 V



 vpe 1



VG 96 923 G-12P

SD.250

 24 V 17.5 mm<sup>2</sup>



 vpe 1



VG 96 923 B1-12P

SD.251

 24 V 17.5 mm<sup>2</sup>



 vpe 1



VG 96 923 B1-12P

SD.252

 24 V 23.5 mm<sup>2</sup>



 vpe 1