

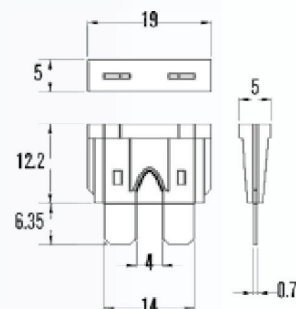



Zekeringen Norm blade fuse - 32V
Fuses DIN ISO 8820-3, JASO D612, SAE J1284
Sicherungen Heat resistant / Self extinguishing Dim.
Fusibles H19.5 x W19 x D5 mm



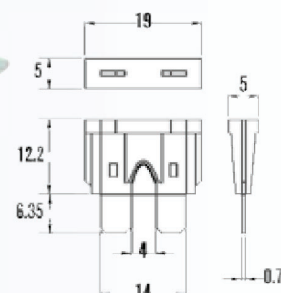

Zekeringen Norm blade fuse - 32V
Fuses DIN ISO 8820-3, JASO D612, SAE J1284
Sicherungen Heat resistant / Self extinguishing Dim.
Fusibles H19.5 x W19 x D5 mm

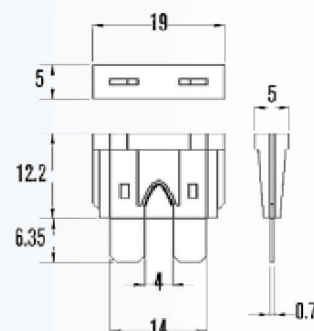







Zekeringen LED Norm blade fuse - 32V
Fuses DIN 72581-3
Sicherungen Heat resistant / Self extinguishing
Fusibles Dim. H19.5 x W19 x D5 mm





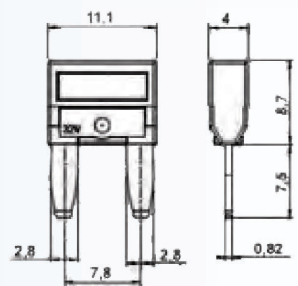

Zekeringen Closed blade fuse - 80V - 19mm
Fuses DIN 1787 gal sn 4 - my UL 94 MO -
Sicherungen Heat resistant / Self extinguishing
Fusibles Dim. H19.5 x W19 x D5 mm







-  Zekeringen Mini blade fuse - 32V
-  Fuses DIN ISO 8820-3, JASO D612, SAE J1284
-  Sicherungen Heat resistant / Self extinguishing Dim.
-  Fusibles H16.2 x W11 x D2.8 mm



-  Zekeringen Mini blade fuse - 32V
-  Fuses DIN ISO 8820-3, JASO D612, SAE J1284
-  Sicherungen Heat resistant / Self extinguishing Dim.
-  Fusibles H16.2 x W11 x D2.8 mm



-  Zekeringen LED Mini blade fuse - 32V
-  Fuses Heat resistant / Self extinguishing
-  Sicherungen Dim. H16.2 x W11 x D4 mm
-  Fusibles

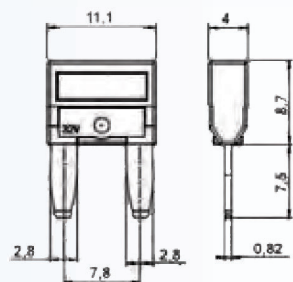

Zekeringen Micro blade fuse FLP - 32V
Fuses JASO D612
Sicherungen Heat resistant / Self extinguishing
Fusibles Dim. H8.7 x W11 mm

FU.7002FLP 2A (25) FU.7003FLP 3A (25) FU.7004FLP 4A (25) FU.7005FLP 5A (25) FU.7006FLP 7.5A (25)

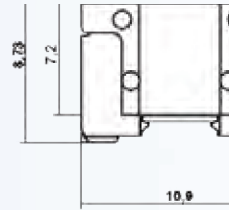

FU.7010FLP 10A (25) FU.7015FLP 15A (25) FU.7020FLP 20A (25) FU.7025FLP 25A (25) FU.7030FLP 30A (25)

Zekeringen Micro 02 blade fuse - 32V
Fuses ISO 8820
Sicherungen Heat resistant / Self extinguishing
Fusibles Dim. H15.3 x W9.1 x D2.8 mm

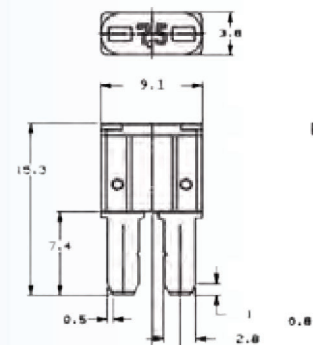

FU.2105 5A (25) FU.2175 7.5A (25) FU.2110 10A (25) FU.2115 15A (25) FU.2120 20A (25) FU.2125 25A (25) FU.2130 30A (25)

Zekeringen Micro 03 blade fuse - 32V
Fuses ISO 8820
Sicherungen Heat resistant / Self extinguishing
Fusibles Dim. H15.3 x W14.3 x D2.8 mm

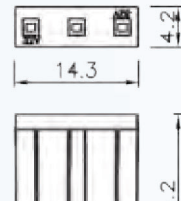

FU.3005 5A (25) FU.3075 7.5A (25) FU.3010 10A (25) FU.3015 15A (25)

Zekeringen Multi blade fuse - 32V
Fuses Heat resistant / Self extinguishing
Sicherungen Dim. H22.9 x W24.3 x D4 mm
Fusibles





Zekeringen Multi6 Mercedes blade fuse - 32V
Fuses Heat resistant / Self extinguishing
Sicherungen Dim. H22.9 x W24.3 x D4 mm
Fusibles



FU.6505
5A (1)





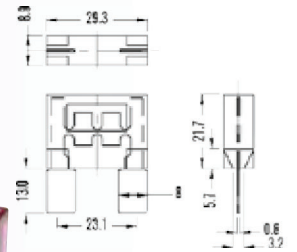

FU.6575
7.5A (1)

-  Zekeringen **Maxi blade fuse - 32V**
-  Fuses **DIN 72581-3**
-  Sicherungen **Heat resistant / Self extinguishing**
-  Fusibles **Dim. H34 x W29.2 x D9 mm**







FU.9020 20A (10) FU.9030 30A (10) FU.9040 40A (10) FU.9050 50A (10) FU.9060 60A (10) FU.9070 70A (10) FU.9080 80A (10) FU.90100 100A (10)

-  Zekeringen **LED Maxi blade fuse - 32V**
-  Fuses **Heat resistant / Self extinguishing**
-  Sicherungen **Dim. H34 x W29.2 x D9 mm**
-  Fusibles







FU.9020LED 20A (10) FU.9030LED 30A (10) FU.9040LED 40A (10) FU.9050LED 50A (10) FU.9056LED 60A (10) FU.9070LED 70A (10) FU.9080LED 80A (10) FU.90100LED 100A (10)

-  Zekeringen **Maxi Compact blade fuse - 32V**
-  Fuses **DIN 72581-3**
-  Sicherungen **Heat resistant / Self extinguishing**
-  Fusibles **Dim. H20 x W16.2 x D6.5 mm**

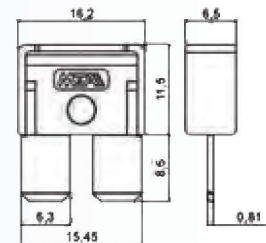

FU.9025MC 25A (5) FU.9030MC 30A (5) FU.9035MC 35A (5) FU.9040MC 40A (5) FU.9050MC 50A (5) FU.9060MC 60A (5)



-  Zekeringen **Maxi Compact M8 blade fuse - 32V**
-  Fuses **DIN 72581-3**
-  Sicherungen **Heat resistant / Self extinguishing**
-  Fusibles **Dim. H20 x W16.2 x D6.5 mm**



FU.9025MC8 25A (5) FU.9030MC8 30A (5) FU.9035MC8 35A (5) FU.9040MC8 40A (5) FU.9050MC8 50A (5) FU.9060MC8 60A (5) FU.9070MC8 70A (5) FU.9080MC8 80A (5)

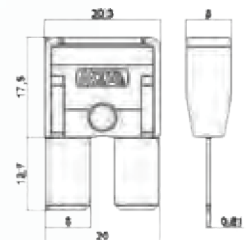

-  Zekeringen
-  Fuses
-  Sicherungen
-  Fusibles

Midi blade fuse - 32V
 Heat resistant / Self extinguishing
 Dim. H8 x W41.5 x D12 mm

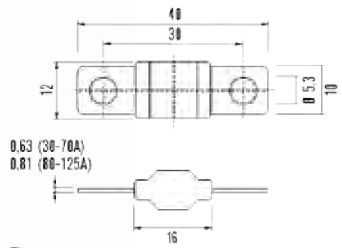

-  Zekeringen
-  Fuses
-  Sicherungen
-  Fusibles

Mega blade fuse - 32V
 Heat resistant / Self extinguishing
 Dim. H9 x W67 x D19 mm

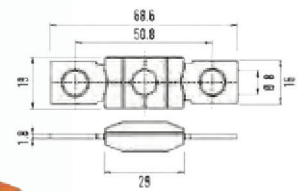

-  Zekeringen
-  Fuses
-  Sicherungen
-  Fusibles

Mega Compact blade fuse - 32V
 Heat resistant / Self extinguishing
 Dim. H8.2 x W55 x D15 mm

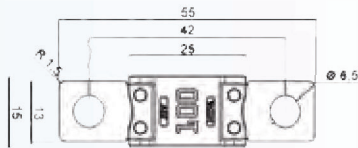



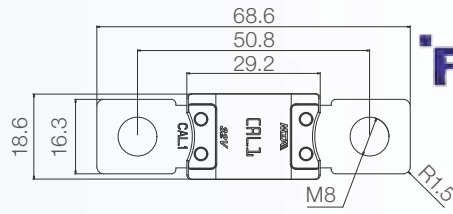

-  Zekeringen
-  Fuses
-  Sicherungen
-  Fusibles

Mega Power blade fuse - 32V
 Heat resistant / Self extinguishing
 Dim. H10.4 x W68.6 x D18.6 mm





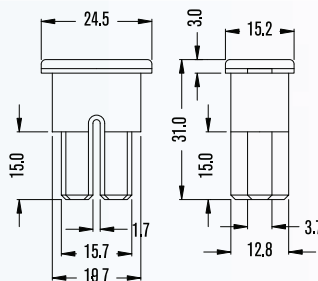

Hoge capaciteit stroomzekering met speciale uitschakelkarakteristiek voor o.a. Renault, Peugeot, Citroen en Fiat. De zekeringen worden tussen accu en b.v. starter of generator geïnstalleerd

-  Zekeringen PAL - japOTO SB fuse - serie AS
-  Fuses JASO D612 - 32V
-  Sicherungen Dim. H31.0 x W24.5 x D15.2 mm
-  Fusibles





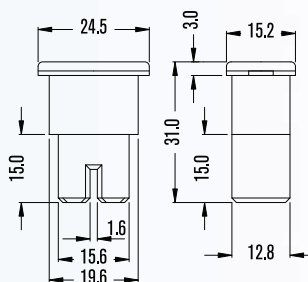

FU.020AS 20A (1) FU.030AS 30A (1) FU.040AS 40A (1) FU.050AS 50A (1) FU.060AS 60A (1) FU.080AS 80A (1) FU.100AS 100A (1) FU.120AS 120A (1) FU.140AS 140A (1)

-  Zekeringen PAL - japOTO SB fuse - serie AX
-  Fuses JASO D612 - 32V
-  Sicherungen Dim. H31.0 x W24.5 x D15.2 mm
-  Fusibles







FU.020AX 20A (1) FU.030AX 30A (1) FU.040AX 40A (1) FU.050AX 50A (1) FU.060AX 60A (1) FU.080AX 80A (1) FU.100AX 100A (1) FU.120AX 120A (1)

-  Zekeringen PAL - japOTO SB fuse - serie B
-  Fuses JASO D612 - 32V
-  Sicherungen Dim. H45.0 x W24.7 x D15.1 mm
-  Fusibles

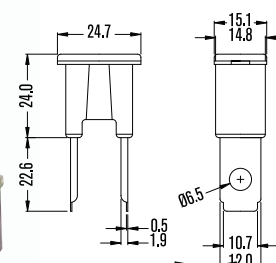

FU.020B 20A (1) FU.030B 30A (1) FU.040B 40A (1) FU.050B 50A (1) FU.060B 60A (1) FU.070B 70A (1) FU.080B 80A (1) FU.100B 100A (1) FU.120B 120A (1) FU.140B 140A (1)



-  Zekeringen PAL - japOTO SB fuse - serie B1
-  Fuses JASO D612 - 32V
-  Sicherungen Dim. H46.6 x W22.2 x D15.0 mm
-  Fusibles



FU.020B1 20A (1) FU.030B1 30A (1) FU.040B1 40A (1) FU.050B1 50A (1) FU.060B1 60A (1) FU.070B1 70A (1) FU.080B1 80A (1) FU.100B1 100A (1) FU.120B1 120A (1)

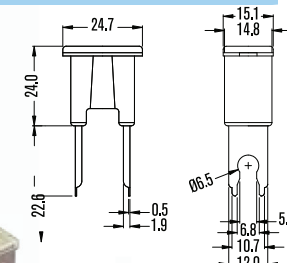

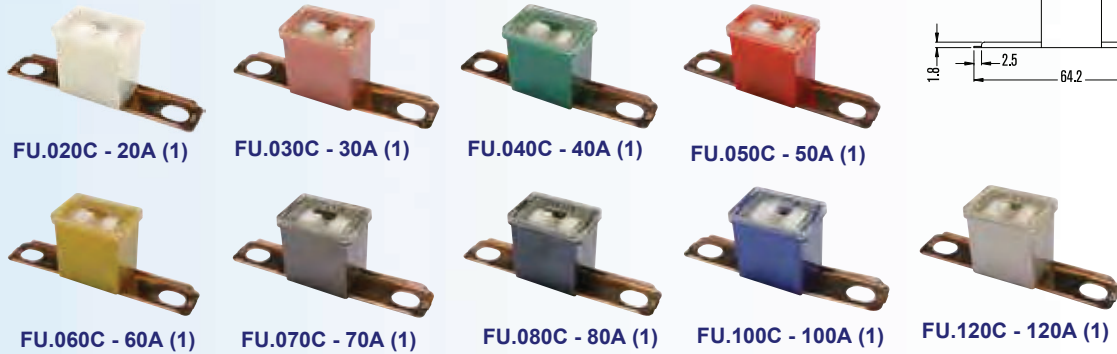
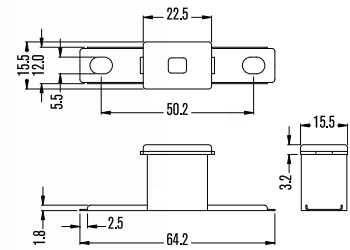

Zekeringen PAL - japOTO SB fuse - serie C
Fuses JASO D612 - 32V
Sicherungen Dim. H21.5 x W62.0 x D14.6 mm
Fusibles



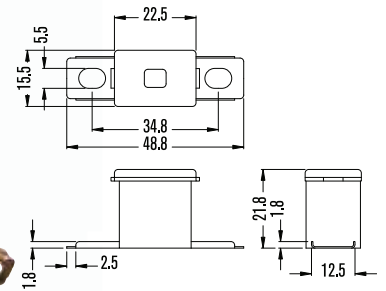

Zekeringen PAL - japOTO SB fuse - serie CS
Fuses JASO D612 - 32V
Sicherungen Dim. H21.5 x W48.0 x D15.0 mm
Fusibles

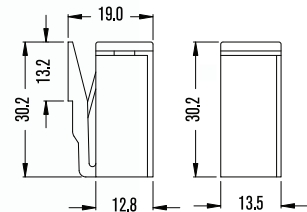

Zekeringen PAL - japOTO SB fuse - serie D
Fuses JASO D612 - 32V
Sicherungen Dim. H31.0 x W13.6 x D13.0 mm
Fusibles

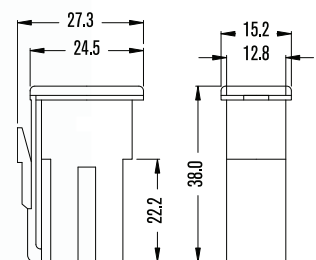

Zekeringen PAL - japOTO SB fuse - serie E
Fuses JASO D612 - 32V
Sicherungen Dim. H37.0 x W22.8 x D15.6 mm
Fusibles





Zekeringen PAL - japOTO SB fuse - serie F
 Fuses JASO D612 - 32V
 Sicherungen Dim. H27.4 x W16.2 x D12.2 mm
 Fusibles



FU.020F 20A (1) FU.030F 30A (1) FU.040F 40A (1) FU.050F 50A (1) FU.060F 60A (1) FU.070F 70A (1) FU.080F 80A (1)

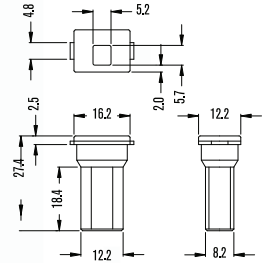

Zekeringen PAL - japOTO SB fuse - serie J1
 Fuses JASO D612 32V
 Sicherungen Dim. H27.0 x W14.1 x D12.0 mm
 Fusibles



FU.020J1 20A (1) FU.025J1 25A (1) FU.030J1 30A (1) FU.040J1 40A (1) FU.050J1 50A (1) FU.060J1 60A (1)

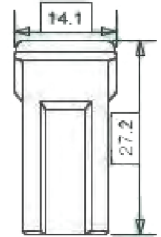

Zekeringen PAL - japOTO SB fuse - serie JLP
 Fuses JASO D612 32V
 Sicherungen Dim. H16.0 x W14.0 x D12.0 mm
 Fusibles



FU.020JLP 20A (1) FU.025JLP 25A (1) FU.030JLP 30A (1) FU.040JLP 40A (1) FU.050JLP 50A (1) FU.060JLP 60A (1)

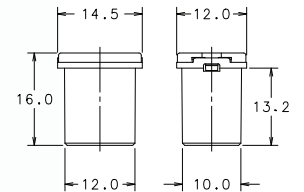

Zekeringen PAL - japOTO SB fuse - serie JM
 Fuses JASO D612 - 32V
 Sicherungen Dim. H15.0 x W10.7 x D12.0 mm
 Fusibles



FU.015JM 15A (1) FU.020JM 20A (1) FU.025JM 25A (1) FU.030JM 30A (1) FU.040JM 40A (1)

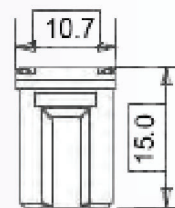

Zekeringen PAL - japOTO SB fuse - serie JMS
 Fuses JASO D612 - 32V
 Sicherungen Dim. H17.5 x W10.7 x D12.0 mm
 Fusibles



FU.015JMS 15A (1) FU.020JMS 20A (1) FU.025JMS 25A (1) FU.030JMS 30A (1) FU.040JMS 40A (1) FU.050JMS 50A (1) FU.060JMS 60A (1)

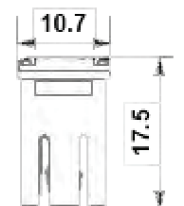

-  CF8 Zekering
-  CF8 Fuse - links
-  CF8 Sicherungseinsätze
-  CF8 Cartouches fusibles



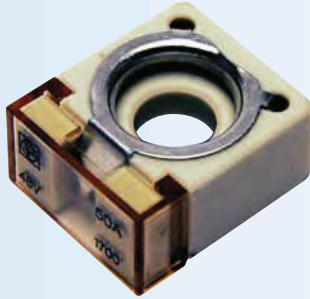

CF8 - Ceramic C221
Dim. 20x11x23
UL94-VO - 58V



FU.044	50A (1)	FU.050	200A (1)
FU.045	75A (1)	FU.051	250A (1)
FU.046	100A (1)	FU.052	300A (1)
FU.047	125A (1)		
FU.048	150A (1)		
FU.049	175A (1)		





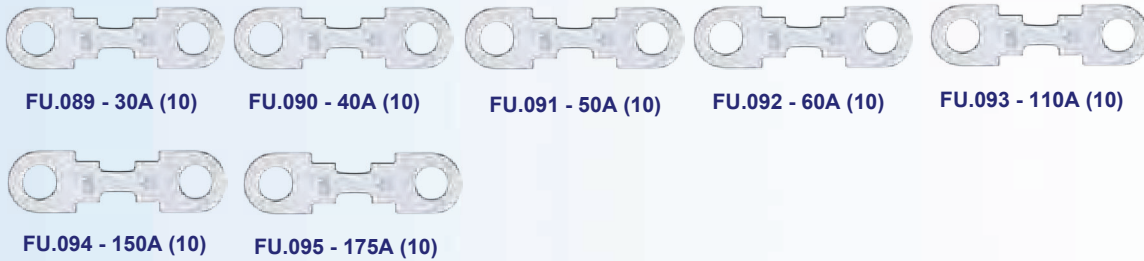
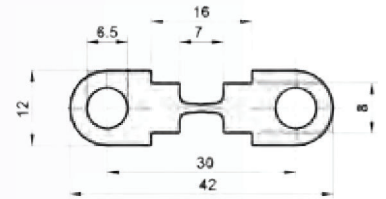

FU.053 (1)
isolatiemoer
insulating nut
Isoliermutter
ecrou isolant

-  Zekeringen - smeltstroken
-  Fuse - strips
-  Sicherungenstreifen
-  Fusibles - lames

Dim. 42x12 mm
DIN 72581/2 - UL 94-VO
12-32V
Audi, Opel, Seat, Skoda, VW





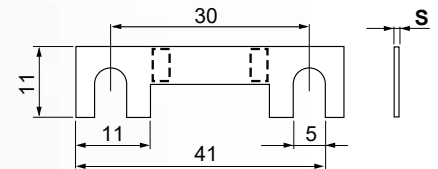

FU.089 - 30A (10) FU.090 - 40A (10) FU.091 - 50A (10) FU.092 - 60A (10) FU.093 - 110A (10)
FU.094 - 150A (10) FU.095 - 175A (10)

-  Zekeringen - smeltstroken
-  Fuse - strips
-  Sicherungenstreifen
-  Fusibles - lames

Dim. 41x11 mm
DIN 72581/2 UL
94-VO
36V



FU.003 - 30A (10) FU.004 - 40A (10) FU.005 - 50A (10) FU.007 - 60A (10)
FU.006 - 80A (10) FU.007 - 100A (10) FU.008 - 120A (10) FU.009 - 150A (10)

-  Zekeringen - smeltstroken
-  Fuse - strips
-  Sicherungenstreifen
-  Fusibles - lames

Dim. 82x20 mm
DIN 43560/1
UL 94-VO
80V

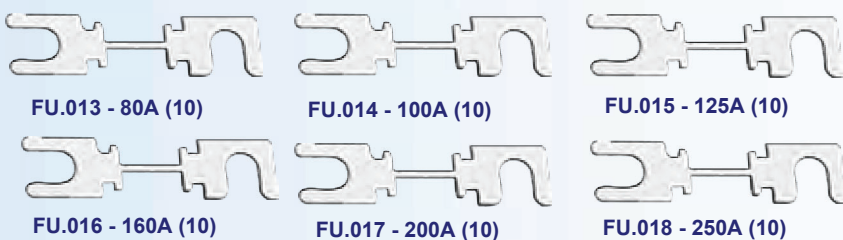

FU.013 - 80A (10) FU.014 - 100A (10) FU.015 - 125A (10)
FU.016 - 160A (10) FU.017 - 200A (10) FU.018 - 250A (10)

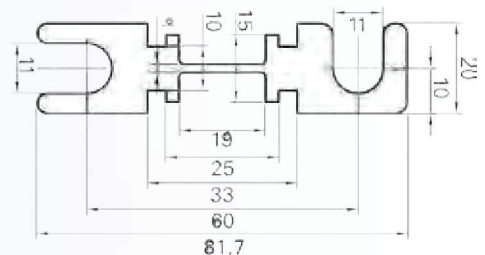

Op aanvraag leverbaar: 40A / 50A / 63A / 135A / 300A / 355A / 425A / 500A

- Zekeringen - smeltstroken
- Fuse - strips
- Sicherungenstreifen
- Fusibles - lames

Dim. 30x11 mm
DIN 72581/2 - UL 94-VO
32V

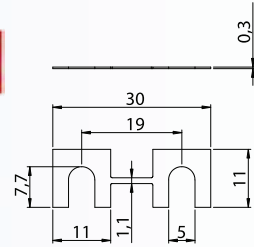

FU.001
30A (10)



FU.002
40A (10)

- Zekeringen - smeltstroken
- Fuse - strips
- Sicherungenstreifen
- Fusibles - lames

Dim. 35x7 mm
FIAT-OM
32V

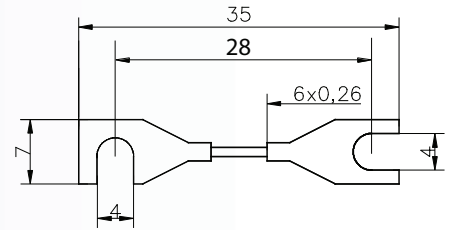

FU.010
25A (10)

- Zekeringen - smeltstroken
- Fuse - strips
- Sicherungenstreifen
- Fusibles - lames

Dim. 82x22 mm
DIN 43560/1
UL 94-VO
32V

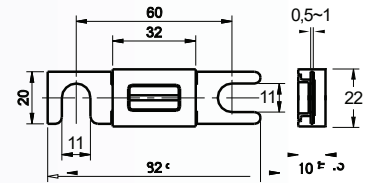

FU.019 - 35A (1)



FU.0001 - 40A (1)



FU.023 - 100A (1)



FU.020 - 50A (1)



FU.021 - 63A (1)



FU.022 - 80A (1)



FU.0003- 150A (1)



FU.025 - 135A (1)



FU.0002- 130A (1)



FU.026 - 160A (1)



FU.0004- 175A (1)



FU.027 - 200A (1)



FU.028 - 250A (1)



FU.0006- 275A (1)



FU.029 - 300A (1)



FU.030 - 355A (1)



FU.0008- 400A (1)



FU.031 - 425A (1)



FU.058 - 500A (1)

- Zekeringen - mini smeltstroken
- Fuse - Mini strips
- Sicherungenstreifen Mini
- Fusibles - lames Mini

Dim. 42.2x16.2 mm
32V

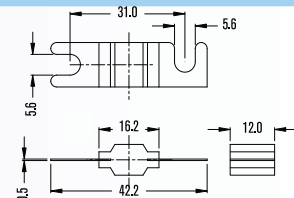

FU.MS030 30A (5)



FU.MS040 40A (5)



FU.MS050 50A (5)



FU.MS060 60A (5)



FU.MS070 70A (5)



FU.MS080 80A (5)



FU.MS100 100A (5)



FU.MS125 125A (5)



FU.MS150 150A (5)



FU.MS200 200A (5)

- Zekeringen - Mega smeltstroken
- Fuse - Mega strips
- Sicherungenstreifen Mega
- Fusibles - lames Mega

Dim. 67.2x19.2 mm 32V

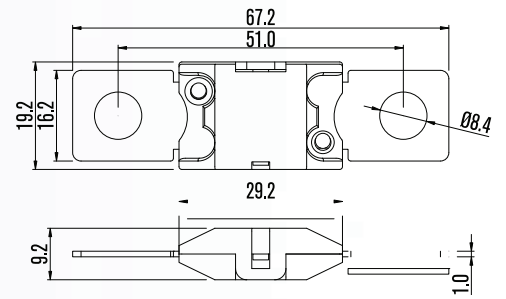

FU.MES100 100A (5)



FU.MES125 125A (5)



FU.MES150 150A (5)



FU.MES175 175A (5)



FU.MES200 200A (5)



FU.MES225 225A (5)



FU.MES250 250A (5)

- Zekeringen
- Fuses
- Sicherungen
- Fusibles

Ceramic fuse
DIN 72581-1
Dim. L25.4 x W6
mm 32V

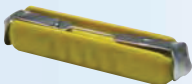
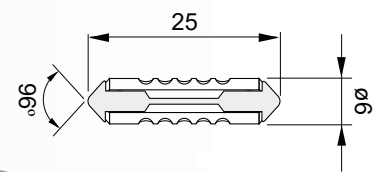

FU.2005 - 5A (100)



FU.2008 - 8A (100)



FU.2016 - 16A (100)

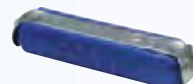

FU.2025 - 25A (100)



FU.2040 - 40A (100)

- Glas zekeringen
- Glass fuses
- Glas-Sicherungen
- Fusibles de verre

Dim. 5x20 mm
IEC 127 - BS4265 - CEE4
32V



FU.4001 - 1A (10)

FU.4001.25 - 1.25A (10)

FU.4001.6 - 1.6A (10)

FU.4002 - 2A (10)

FU.4002.5 - 2.5A (10)

FU.4003 - 3.15A (10)

FU.4004 - 4A (10)

FU.4005 - 5A (10)

FU.4006 - 6.3A (10)

FU.4008 - 8A (10)

FU.4010 - 10A (10)

FU.4012 - 12A (10)

FU.4015 - 15A (10)

FU.4016 - 16A (10)

FU.4020 - 20A (10)

FU.4100 - 100MA (10)

FU.4200 - 200MA (10)

FU.4250 - 250MA (10)

FU.4300 - 300MA (10)

FU.4400 - 400MA (10)

FU.4500 - 500MA (10)

FU.4800 - 800MA (10)

Glas zekeringen TRAAG
FU.4010T - 10A (10)

- Glas zekeringen
- Glass fuses
- Glas-Sicherungen
- Fusibles de verre

Dim. 6.35x32 mm
IEC 127 - BS4265 - CEE4
32V



FU.5001 - 1A (10)

FU.5002 - 2A (10)

FU.5002.5 - 2.5A (10)

FU.5003 - 3A (10)

FU.5004 - 4A (10)

FU.5005 - 5A (10)

FU.5006 - 6A (10)

FU.5008 - 8A (10)

FU.5010 - 10A (10)

FU.5015 - 15A (10)

FU.5020 - 20A (10)

FU.5025 - 25A (10)

FU.5030 - 30A (10)

FU.5035 - 35A (10)

FU.5050 - 50A (10)

Glas zekeringen TRAAG

FU.5010TR - 10A (10)

- Automatische zekeringen
- Automatic fuses
- Sicherungsautomaten
- Fusible automatiques

DIN 446244 - A6.3-0.8
-30°C / +60°C
12V VW / AUDI



FU.040
12A (1)





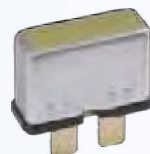

FU.041
15A (1)



FU.042
20A (1)



FU.043
30A (1)

-  Automatische zekeringen
-  Automatic fuses
-  Sicherungsautomaten
-  Fusible automatiques

DIN 72581/3C - IP54
 -30°C / +60°C
 24V



FU.054
5A (1)



FU.061
6A (1)



FU.055
8A (1)



FU.032
10A (1)



FU.033
15A (1)

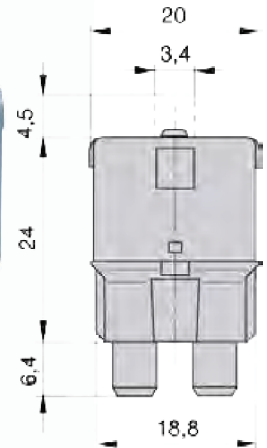

FU.034
20A (1)







FU.035
25A (1)



FU.101
30A (1)



FU.102
40A (1)

-  Automatische zekeringen
-  Automatic fuses
-  Sicherungsautomaten
-  Fusible automatiques

DIN 72581/3C - IP54
 -30°C / +60°C
 24 - 32V



FU.111
5A (1)



FU.062
6A (1)



FU.112
7.5A (1)



FU.113
10A (1)



FU.114
15A (1)



FU.115
20A (1)

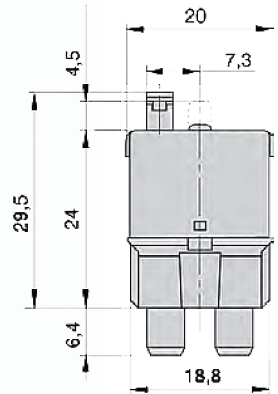





FU.116
25A (1)



FU.117
30A (1)



FU.118
40A (1)

-  Automatische zekeringen
-  Automatic fuses
-  Sicherungsautomaten
-  Fusible automatiques

DIN 446244 - A6.3-0.8
 -30°C / +60°C
 12V



FU.801
5A (1)



FU.802
6A (1)



FU.803
8A (1)



FU.804
10A (1)



FU.805
15A (1)





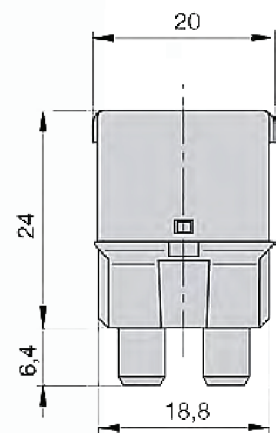

FU.806
20A (1)



FU.807
25A (1)



FU.808
30A (1)

-  Automatische zekeringen
-  Automatic fuses IP67
-  Sicherungsautomaten 48V
-  Fusible automatiques

Art.nr	Type	Amp	Stud Size	VPE
FU.9100	HCB50S	50	1/4"	1
FU.9101	HCB60S	60	1/4"	1
FU.9102	HCB80S	80	1/4"	1
FU.9103	HCB100S	100	1/4"	1
FU.9104	HCB150S	150	1/4"	1
FU.9105	HCB200S	200	3/8"	1



Meestal gebruikt in hulp- en accessoirecircuits in vrachtwagens, bussen, campers en maritieme systemen. Afgedicht voor toepassingen in motorruimte en lensruimte. Inclusief beschermknoppen Conformiteit: SAE J1171 (beveiligd tegen ontsteking), SAE J1625. Ingress-bescherming: IP67 Voltage: 48Vdc. Onderbrekingsbeoordeling: 3000A @ 30Vdc. Bedrijfstemperatuur: -32 °C tot 82 °C Opslagtemperatuur: -34 °C tot 149 °C. Materiaal: zwart UL-gecertificeerd 94V0 thermohardend kunststof Inclusief beschermknoppen.

-  Zekeringhouders Mini
-  Fuseholders Mini
-  Sicherungshalter Mini
-  Porte fusible Mini

DIN 72581/3C
-30°C / +60°C



UL 94-VO - UL 275 - SAE



FU.927 - Mini fuse 2-20A (10)



FU.928 - Mini fuse 2-30A (10)



FU.928L - Mini fuse 2-30A (10)



FU.973
Circuit zekeringhouder voor 2 mini steekzekeringen 2-30A 1.3mm² (AWG 16) rode kabel, lengte 100mm, met blauwe doorverbinder. (10)







FU.975
Circuit zekeringhouder voor 2 mini steekzekeringen 2-30A 1.3mm² (AWG 16) rode kabel, lengte 100mm, met aansluit blok 6.3 mm. (10)



FU.991
Circuit zekeringhouder voor 3 mini steekzekeringen 2-30A 1.5mm² (AWG 16) rode kabel, lengte 100mm, met blauwe doorverbinder. (5)





FU.992
Circuit zekeringhouder voor 3 mini steekzekeringen 2-30A 1.5mm² (AWG 16) rode kabel, lengte 100mm, met aansluit blok 6.3 mm. (5)

-  Zekeringhouders Norm
-  Fuseholders Norm
-  Sicherungshalter
-  Porte fusible Norm

DIN 72581/3C
 -30°C / +60°C
 UL 94-VO - UL 275 - SAE



FU.929 - Norm fuse 2-20A (10)

 Ø 2.0 mm² 



FU.930 - Norm fuse 2-30A (10)

 Ø 3.0 mm²



FU.930-L - Norm fuse 2-30A (10)

 Ø 3.0 mm² 

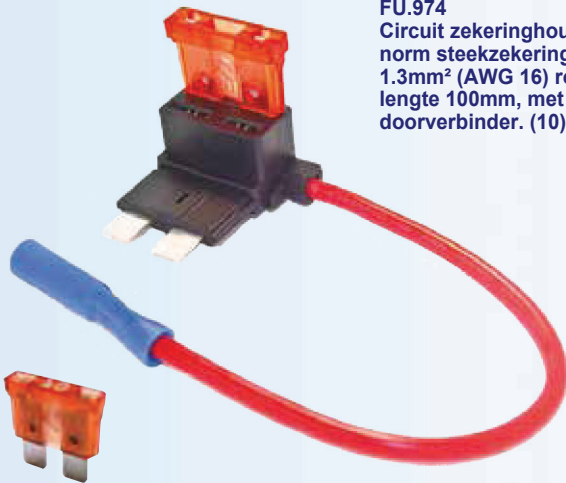

FU.974
 Circuit zekeringhouder voor
 norm steekzekeringen 2-40A
 1.3mm² (AWG 16) rode kabel,
 lengte 100mm, met blauwe
 doorverbinder. (10)





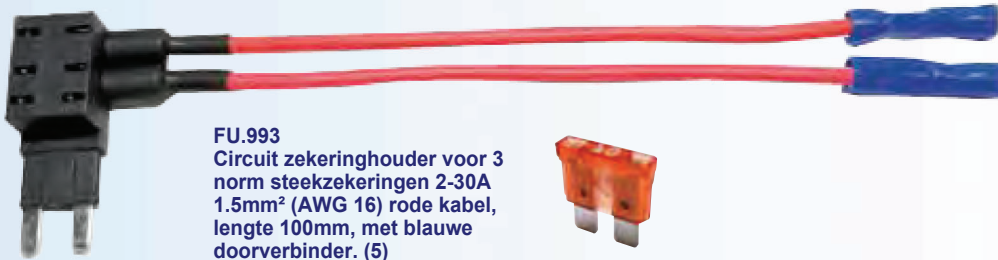

FU.976
 Circuit zekeringhouder voor
 norm steekzekeringen 2-40A
 1.3mm² (AWG 16) rode kabel,
 lengte 100mm, met aansluit
 blok 6.3 mm. (10)



FU.993
 Circuit zekeringhouder voor 3
 norm steekzekeringen 2-30A
 1.5mm² (AWG 16) rode kabel,
 lengte 100mm, met blauwe
 doorverbinder. (5)



FU.994
 Circuit zekeringhouder voor 3
 norm steekzekeringen 2-30A
 1.5mm² (AWG 16) rode kabel,
 lengte 100mm, met aansluit
 blok 6.3 mm. (5)

-  Zekeringhouders Norm
-  Fuseholders Norm
-  Sicherungshalter
-  Porte fusible Norm

DIN 72581/3C
 -30°C / +60°C
 UL 94-VO - UL 275 - SAE



FU.961 - Norm fuse 2-30A (10)

 Ø 1.5 mm²

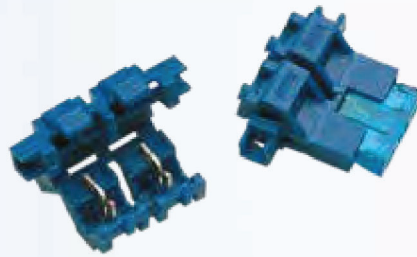

FU.972 Norm fuse 2-40A (10)

 Ø 1.5 mm²



FU.922 - Norm fuse FHA16 2-30A (10)



FU.933 - Norm fuse FHA14 2-40A (10)

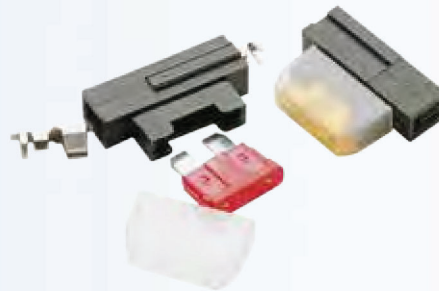

FU.934 - Norm fuse FHA20 2-40A (10)



FU.960 - Ø 3.0 mm² Norm fuse 2-40A (10)

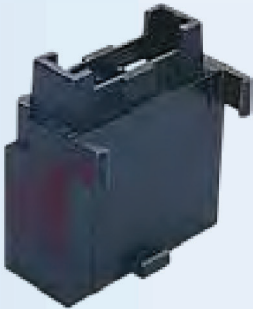

FU.920 - Norm fuse 2-30A (10)

 Ø 1.5 mm²



FU.910
 fixing plate FU.920 (10)





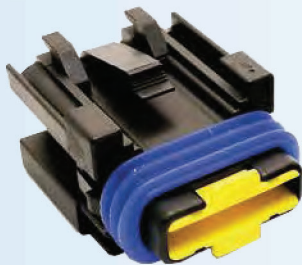

FU.911
 cover FU.912 (10)



FU.9097 - Norm fuse Sealed 20A incl. contacten (1)



-  Zekeringhouders Mini FLP
-  Fuseholders Mini FLP
-  Sicherungshalter Mini FLP
-  Porte fusible Mini FLP

DIN 72581/3C
 -30°C / +60°C
 UL 94-VO - UL 275 - SAE



FU.981
 Zekeringhouder voor FLP mini steekzekeringen 2-30A 3.0mm² (gele kabel, lengte 100mm) (1)

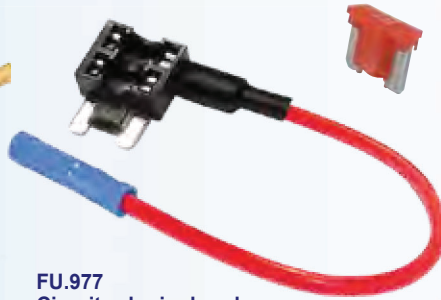

FU.977
 Circuit zekeringhouder voor 2 FLP mini steekzekeringen 2-30A 1.3mm² (AWG 16) rode kabel, lengte 100mm, met blauwe doorverbinder. (10)

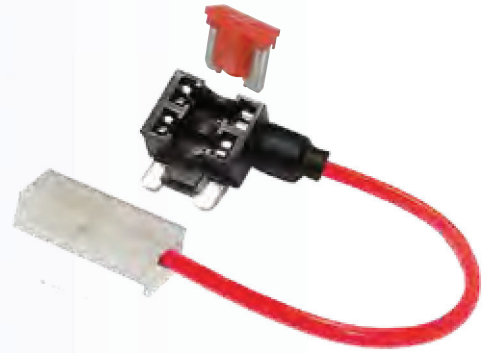





FU.978
 Circuit zekeringhouder voor 2 FLP mini steekzekeringen 2-30A 1.3mm² (AWG 16) rode kabel, lengte 100mm, met aansluit blok 6.3 mm. (10)



FU.995
 Circuit zekeringhouder voor 3 FLP mini steekzekeringen 2-30A 1.3mm² (AWG 16) rode kabel, lengte 100mm, met blauwe doorverbinder. (5)



FU.996
 Circuit zekeringhouder voor 3 FLP mini steekzekeringen 2-30A 1.3mm² (AWG 16) rode kabel, lengte 100mm, met aansluit blok 6.3 mm. (5)

-  Zekeringhouders Micro 2
-  Fuseholders Micro 2
-  Sicherungshalter Micro 2
-  Porte fusible Micro 2





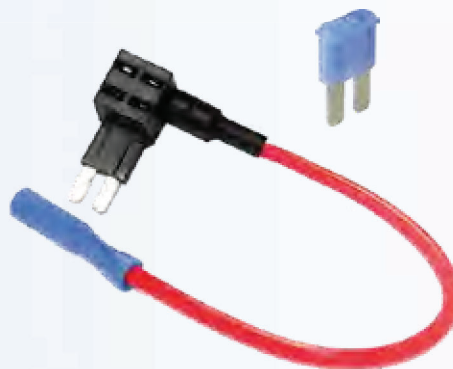

FU.987
 Zekeringhouder voor Micro 2 steekzekeringen 2-30A 1.3mm² (AWG 16) rode kabel, lengte 100mm. (10)

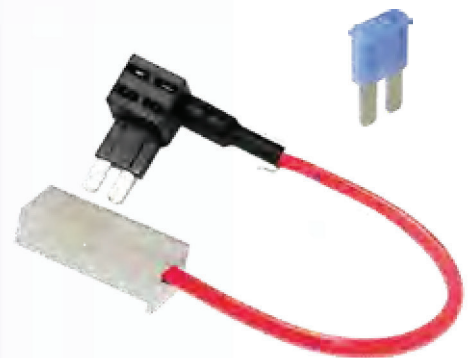

FU.979
 Circuit zekeringhouder voor 2 Micro 2 steekzekeringen 2-30A 1.3mm² (AWG 16) rode kabel, lengte 100mm, met blauwe doorverbinder. (10)



FU.980
 Circuit zekeringhouder voor 2 Micro 2 steekzekeringen 2-30A 1.3mm² (AWG 16) rode kabel, lengte 100mm, met aansluit blok 6.3 mm. (10)





-  Zekeringhouders Micro 2
-  Fuseholders Micro 2
-  Sicherungshalter Micro 2
-  Porte fusible Micro 2



FU.997
Circuit zekeringhouder voor 3 Micro 2 steekzekeringen 2-30A 1.3mm² (AWG 16) rode kabel, lengte 100mm, met blauwe doorverbinder. (5)



FU.998
Circuit zekeringhouder voor 3 Micro 2 steekzekeringen 2-30A 1.3mm² (AWG 16) rode kabel, lengte 100mm, met aansluit blok 6.3 mm. (5)

-  Zekeringhouders Micro 3
-  Fuseholders Micro 3
-  Sicherungshalter Micro 3
-  Porte fusible Micro 3



FU.9093
Zekeringhouder voor Micro 3 steekzekeringen 2-30A (10)
Ø 1.5 mm²







FU.9094
Zekeringhouder voor Micro 3 steekzekeringen 2-30A (10)
Ø 1.5 mm²



FU.9091
Circuit zekeringhouder voor 2 Micro 3 steekzekeringen 2-30A 1.3mm² (AWG 16) rode kabel, lengte 100mm, met blauwe doorverbinder. (5)



FU.9092
Circuit zekeringhouder voor 2 Micro 3steekzekeringen 2-30A 1.3mm² (AWG 16) rode kabel, lengte 100mm, met aansluit blok 6.3 mm. (5)





-  Zekeringhouders JLP / J
-  Fuseholders JLP / J
-  Sicherungshalter JLP / J
-  Porte fusible JLP / J



FU.985 JLP Fuses (1)



FU.984 J Fuses (1)

-  Zekeringhouders Maxi
-  Fuseholders Maxi
-  Sicherungshalter Maxi
-  Porte fusible Maxi

DIN 72581/3C
 -30°C / +60°C
 UL 94-VO - UL 275 - SAE



FU.936 - maxi fuse 20-100A
 wire Ø 3.0 mm2 (1)



FU.MAB1 - maxi fuse max 70A
 wire Ø 2.5-6.0 mm2 wire Ø 6.0-10.0
 mm2 (1 set)

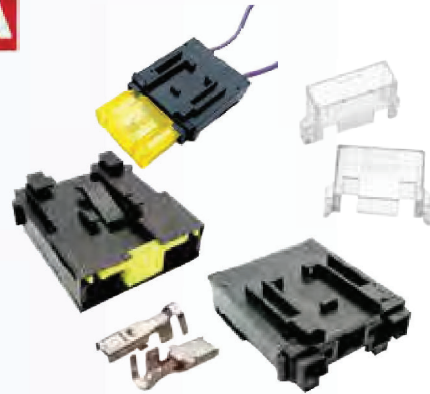

FU.9095 - maxi fuse 20-100A
 wire Ø 4.0 - 6.0 mm2 incl. kap + 2 contacten
 (1 set)







FU.938 - maxi fuse 20-100A
 wire Ø 2.5-4.0 mm2 IP54 (1 set)



FU.939 - maxi fuse 20-100A
 wire Ø 4.0-6.0 mm2 IP54 (1 set)



FU.940 - maxi fuse 20-100A
 wire Ø 6.0-10.0 mm2 IP54 (1 set)

-  Zekeringhouders
-  Fuseholders
-  Sicherungshalter
-  Porte fusible

DIN 72581 - DIN 43560 - ISO 8820
 -30°C / +60°C
 UL 94-VO - UL 275 - SAE



FU.924
 incl. 8A ceramic fuse (10)

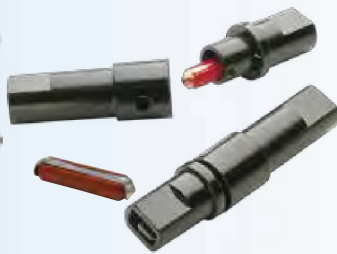





FU.925
 incl. 8A ceramic fuse (10)



FU.926
 incl. 2A glass fuse (10)



FU.935
 glassuniv, 5x20 /6x32 (10)

-  Zekeringhouders Mega
-  Fuseholders Mega
-  Sicherungshalter Mega
-  Porte fusible Mega

DIN 72581 - DIN 43560 - ISO 8820
 -30°C / +60°C
 UL 94-VO - UL 275 - SAE



FU.944 - Mega fuse 100-500A
 10/16/25/35 mm2 (1)



FU.945 - Mega fuse 100-500A
 121x45x37 (1)



FU.966 - Mega fuse 100-500A
 100x44x46 (1)



Zekeringhouders Mega
 Fuseholders Mega
 Sicherungshalter Mega
 Porte fusible Mega

DIN 72581 - DIN 43560 - ISO 8820
 -30°C / +60°C
 UL 94-VO - UL 275 - SAE

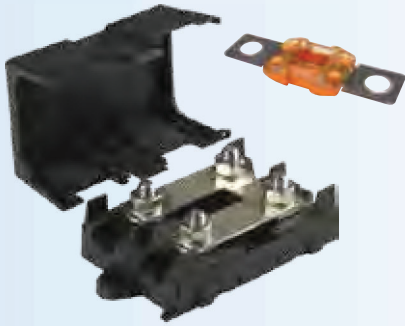

FU.967 - Mega fuse 100-500A
 128x54x66 (1)



FU.986 - Mega fuse 100-500A
 121x45x37 (1)



Zekeringhouders Midi - Strip
 Fuseholders Midi - Strip
 Sicherungshalter Midi - Strip
 Porte fusible Midi - Strip

DIN 72581 - DIN 43560 - ISO 8820
 -30°C / +60°C
 UL 94-VO - UL 275 - SAE



FU.923 - Midi fuse / Strip fuse 42x12
 121x45x37 (1)



FU.946 - Midi fuse / Strip fuse 42x12
 121x45x37 (1)

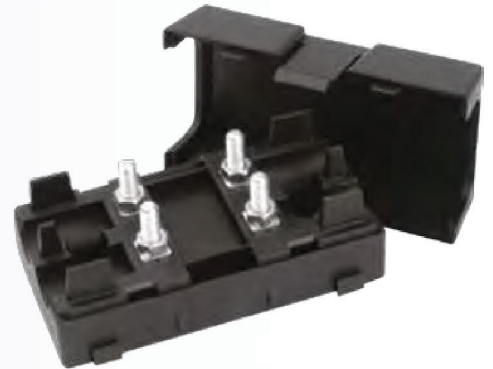

FU.941
 Midi fuse / Strip fuse 42x12 (1)



FU.968 - 3P Midi fuse / Strip fuse 42x12
 116x29x50 incl. seals (1)



FU.942 - 4P Midi fuse / Strip fuse 42x12
 116x29x50 (1)



FU.956
 conn.strip 2p. for FU.941/FU.942 (1)



FU.957
 conn.strip 4p. for FU.942 (1)



Zekeringhouders Combi Midi - Mega
 Fuseholders Combi Midi - Mega
 Sicherungshalter Combi Midi - Mega
 Porte fusible Combi Midi - Mega

DIN 72581 - DIN 43560 - ISO 8820
 -30°C / +60°C
 UL 94-VO - UL 275 - SAE



FU.965
 Combi-holder Midi-Mega fuse (1)

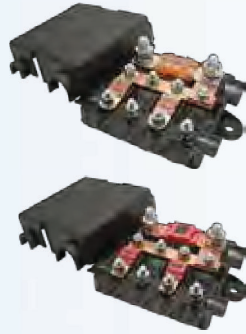

FU.982
 conn.strip 4p. for FU.965 (1)



Zekeringhouders Strip
 Fuseholders Strip
 Sicherungshalter Strip
 Porte fusible Strip

DIN 72581 - DIN 43560 - ISO 8820
 -30°C / +60°C
 UL 94-VO - UL 275 - SAE



FU.958
 Fuse strip 30/450A 82x20 (1)

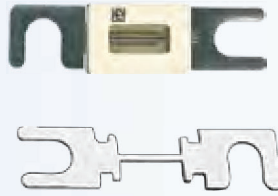

FU.963
 Fuse strip 30/450A 82x20 (1)



Zekeringdozen met LED
 Fuseboxes with LED
 Sicherungsdosen mit LED
 Boîte à fusibles avec LED

-20°C - +85°C







FU.988 - 4p Fuse box + LED
 Norm Fuse 1 - 30A
 LWH 49.0 x 85.0 x35.5



FU.989 - 6p Fuse box + LED
 Norm Fuse 1 - 30A
 LWH 49.0 x 85.0 x35.5



-  Zekeringdozen met LED
-  Fuseboxes with LED
-  Sicherungsdosen mit LED
-  Boîte à fusibles avec LED

-20°C - +85°C



FU.990 - 10p Fuse box + LED
Norm Fuse 1 - 30A
LWH 95.0 x 85.0 x35.5







Zekeringhouder van 10 -30 volt , 25ampere per uitgang . met mogelijkheid om 6 reserve zekeringen te plaatsen ! De tab terminals aan de onderkant zijn 6,3x0.8mm deze zekeringsdoos is volledig waterdicht , indien zekering niet meer heel is gaat de LED branden! Output 25 Amp. max. per circuit.
 Maat: tab size 6,3 x0.8mm, 6.4 mm quick connectterminal

FU.999 - Waterproof 10p Fuse box + LED
Inbouw - Norm Fuse 1 - 30A
LWH 109.0 x 75.0 x37.0







FU.9106 - 10p Fuse box + LED
FLP Fuse 2 - 30A
LWH 95.0 x 85.0 x35.5

-  Zekeringdozen met LED
-  Fuseboxes with LED
-  Sicherungsdosen mit LED
-  Boîte à fusibles avec LED

-20°C - +85°C



FU.9107 - 10p Fuse box + LED
MINI Fuse 2 - 30A
LWH 95.0 x 85.0 x35.5

-  Zekeringdozen
-  Fuseboxes
-  Sicherungsdosen
-  Boîte à fusibles

-20°C - +85°C



FU.9098 - 6p Zekeringkast
Norm Fuse 1 - 30A
L125 x W95 x D59 mm (incl.deksel)
vpe 1

Zekeringkast voor 6 zekeringen, bestaande uit 2 positieve en 1 negatieve rail.
Geschikt voor de automotive & marine industrie.





Voltage(Max):32DC
 Input Terminal Rating:M5 schroefdraadbouten(max. 100A)
 Beoordeling uitgangsaansluiting:30A/30A max.Belasting per circuit
 Torque Rating:20in-lb(2,25Nm)max Ratingkoppel:max.0,9Nm(8in-lb) Temperatuurbeoordeling:-25°C tot +85°C
 Materiaal:CoverPC(helder) Behuizingenbasis:PBT(zwart) Terminal:vertind koper - Rating:100AMax



FU.9099 - 12p Zekeringkast
Norm Fuse 1 - 30A
L164 x B95 x D59 mm (inclusief deksel)
vpe 1

Zekeringkast voor 12 zekeringen, bestaande uit 2 positieve en 1 negatieve rail.
Geschikt voor de automotive & marine industrie.

Voltage (Max): 32 DC - Input Terminal Rating: M5 schroefdraadbouten (max. 160A)
 Beoordeling uitgangsaansluiting: 30A / 30A max. Belasting per circuit
 Torque Rating: 20 in-lb (2,25 Nm) max.
 Montagekoppel Rating: 8 in-lb (0,9 Nm) max
 Temperatuurbeoordeling: -25 ° C tot + 85 ° C - Materiaal: Cover PC (helder)
 Behuizing en basis: PBT (zwart) - Terminal: vertind koper - Beoordeling: 100A Max

-  Zekeringdozen
-  Fuseboxes
-  Sicherungsdosen
-  Boîte à fusibles

DIN 72581 - DIN 43560 - ISO 8820
 -30°C / +60°C
 UL 94-VO - UL 275 - SAE



FU.913 - Norm Fuse univ. 4P - 65x57x26 (1)



FU.918 - Norm Fuse univ. 4P - 79x37x46 (1)



FU.914 - Norm Fuse univ. 6P - 85x57x27 (1)



FU.916 - Norm Fuse univ. 6P - 98x37x27 (1)



FU.915 - Norm Fuse univ. 6P - 96x25x24 (1)







FU.969 - Norm Fuse IP53 univ. 6P - 110x43.5x29 (1)



FU.917 - Norm Fuse univ. 8P - 119x37x46 (1)



FU.959 - Norm Fuse univ. 8P - 115x42x32 (1)

-  Zekeringdozen
-  Fuseboxes
-  Sicherungsdosen
-  Boîte à fusibles

DIN 72581 - DIN 43560 - ISO 8820
 -30°C / +60°C
 UL 94-VO - UL 275 - SAE



FU.970 - Norm Fuse IP53 univ. 8P - 142x43.5x29 (1)







FU.971 - Norm / Auto Fuse univ. 8P 118x61x29 (1)



FU.964 - Norm Fuse univ. 16P 130x64x89 (1)



FU.9096 - Norm Fuse univ. 16P 130x64x89 (1)

-  Zekeringdozen
-  Fuseboxes
-  Sicherungsdosen
-  Boîte à fusibles

DIN 72581 - DIN 43560 - ISO 8820
 -30°C / +60°C
 UL 94-VO - UL 275 - SAE



FU.905 - Ceramic Fuse univ. 2P (1)



FU.947 - Ceramic Fuse univ. 2P (1)



FU.906 - Ceramic Fuse univ. 4P (1)



FU.948 - Ceramic Fuse univ. 4P (1)



FU.907 - Ceramic Fuse univ. 6P (1)



FU.949 - Ceramic Fuse univ. 6P (1)



FU.908 - Ceramic Fuse univ. 8P (1)



FU.950 - Ceramic Fuse univ. 8P (1)







FU.951 - Ceramic Fuse univ. 10P (1)

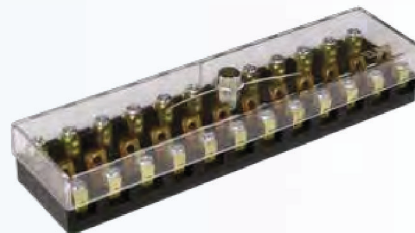

FU.909 - Ceramic Fuse univ. 12P (1)



FU.952 - Ceramic Fuse univ. 12P (1)



-  Relaisouder mini /micro relais
-  Relayholder mini /micro relais
-  Relaishalter mini /mikro relais
-  Support de relais mini / micro



SR.119
 RELAIS BLOK VOOR
 7 MICRO RELAIS
 incl. contacten
 vpe 1



SR.120
 RELAIS BLOK VOOR
 4 MINI RELAIS
 incl. contacten
 vpe 1

-  Zekeringen - accessoires
-  Fuses - accessories
-  Sicherungen - Zubehör
-  Fusibles - accessoires



FU.953
Fuse tester - mini/norm (1)

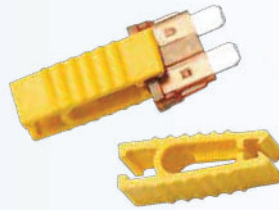

FU.901
Fuse extr. norm/glas (10)







FU.954
Fuse extr. norm/glas (10)

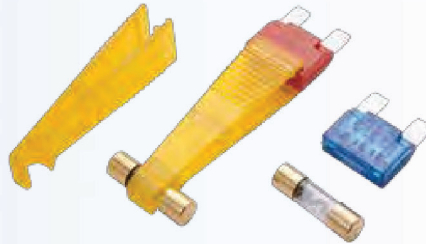

FU.955
Fuse extr. mini/glas (10)



FU.962
Fuse extr. maxi/glas (10)

-  Zekeringen - accessoires
-  Fuses - accessories
-  Sicherungen - Zubehör
-  Fusibles - accessoires

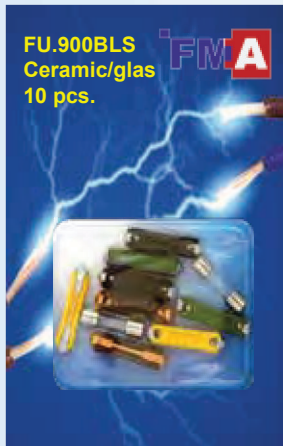

FU.900BLS Ceramic/glas
10 pcs. (1)

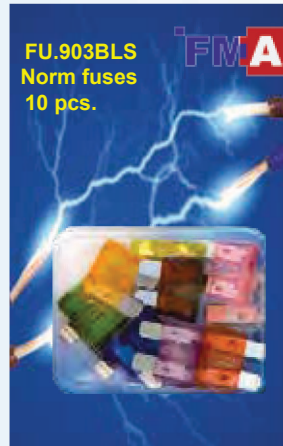

FU.903BLS Norm fuses
10 pcs. (1)

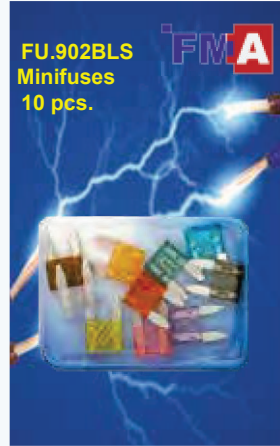

FU.902BLS Mini fuses
10 pcs. (1)



FU.899BLS MiniFLP fuses
10 pcs. (1)