



# 15



Kabel verbindingsdozen



Cable connecting boxes







Leitungsverbindungsdozen



Boîtiers d'accouplement



-  Kabel verbindingsdozen en accessoires
-  Cable connecting boxes - Accessories
-  Leitungsverbindungsdozen - Zubehör
-  Boîtiers d'accouplement - Accessoires

### 6 Polig



6P - M4

WD.002 1

mat. PVC / Aluminium

AK 19601 - 120 x 69 x 30 mm



WD.006 1

mat. Aluminium

AK 19681



6P - M4

WD.011 1

mat. PVC

AK 360 - 125 x 73 x 32 mm

### 8 Polig



8P - 32 aansluitingen

WD.003 1

mat. PVC Aluminium 8P - 32C

AK 19804 - 150 x 93 x 45 mm



WD.007 1

mat. Aluminium

AK 19681



WD.008 1

8 x 4

AK 19851



WD.010 1

mat. PVC 8P

AK 363 - 125 x 73 x 32 mm



WD.012 1

mat. PVC 8P x 2

AK 364 - 125 x 73 x 32 mm



WD.004 1

mat. PVC 8P - 32C

AK 208 - 120 x 87 x 36 mm

### 12 Polig



WD.100 1

mat. PVC 12P x 2C

AK 208100 - 120 x 87 x 36 mm



WD.101 1

mat. PVC 12P x 4C





AK 208101 - 140 x 97 x 50 mm



WD.102 1

mat. PVC 12P x 4C

AK 208102 - 140 x 107 x 50 mm

-  Kabel verbindingsdozen en accessoires
-  Cable connecting boxes - Accessories
-  Leitungsverbindungsdozen - Zubehör
-  Boîtiers d'accouplement - Accessoires



16 Polig

WD.103 1

mat. PVC 16P x 2C  
AK 208103 - 120 x 87 x 36 mm



24 Polig

WD.104 1

mat. PVC 24P x 2C  
AK 208104 - 140 x 107 x 50 mm



WD.005 1 zonder interieur - IP 54  
mat. PVC Aluminium 12P -28C  
AK 19904 - 151 x 93 x 55 mm



WD.009 1  
28C  
AK 19951

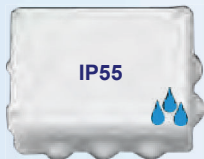

WD.013 1  
100 x 100 x 50 mm



WD.014 1  
50 x 110 x 70



WD.015 1  
180 x 140 x 80 mm

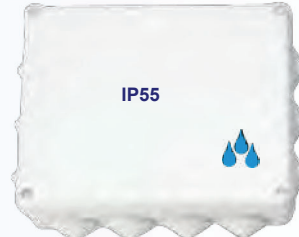

WD.016 1  
240 x 190 x 90 mm

IP55



IP55



IP55







IP55

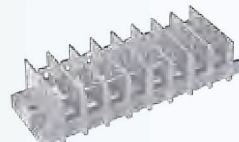

WD.038 1  
12P / 6X8 WIT  
> WD.013 / 014 / 015 / 016







WD.039 1  
8P / 4X8 GRIJS  
> WD.013 / 014 / 015 / 016

-  Verbindingsdoos met 4 kabelingen- kunststof huis en deksel - slagvast - zonder interieur
-  Connecting box with 4 cable entries - impact resistant synthetic housing and cover - without interior
-  Verbindungsdose mit 4 x Kabeleingang- Kunststoff Gehäuse und Deckel - Ohne Einsatz
-  Boîtier d'accouplement à 4 x entrée de câble- Boîte et couvercle en matière plastique - sans intérieur



WD.105 1  
146 x 101 x 47 mm



-  Verbindingsdoos met 8 kabelingen- kunststof huis en deksel - slagvast - uitneembaar interieur - 4 x 14 vlakstekeraansluitingen
-  Connecting box with 8 cable entries - impact resistant synthetic housing and cover - 4 x 14 blade terminal connection - removable interior
-  Verbindungsdose mit 8 x Kabeleingang- Kunststoff Gehäuse und Deckel - Einsatz herausnehmbar - 4 x 14 Flachsteckanschlüsse
-  Boîtier d'accouplement à 8 x entrée de câble- Boîte et couvercle en matière plastique - Intérieur détachable - 4 x 14 contacts plans





WD.106 1  
146 x 101 x 47 mm



 Verbindingsdoos ADR / GGVS 28 polig met 8 kabelingangen- kunststof huis - slagvast - metalen deksel - beugelsluiting - met interieur en tulen 4 x PG 11- 4 x PG 13 - IP 69K

 Connecting box ADR / GGVS 28 pins with 8 cable entries- impact resistant synthetic housing - metal cover-strap locking - with interior and rubber seals 4 x PG 11- 4 x PG 13 - IP 69K

 Verbindungsdose ADR / GGVS 28 polig mit 8 x Kabeleingang- Kunststoff Gehäuse - Schlagfest - Metall Deckel - Bügelverschluss - mit Einsatz und Tüllen 4 x PG 11- 4 x PG 13 - IP 69K

 Boîtier d'accouplement, ADR / GGVS à 28 pôles, 8 x entrée de câble- Boîte en matière plastique - résistant aux chocs - couvercle métallique - fermeture à étrier - avec insert et joints d'étanchéité 4 x PG 11- 4 x PG 13 - IP 69K





WD.017 1

AK 19036 GGVS

190 x 80 x 135



 Verbindingsdoos met 8 kabelingangen- kunststof huis - slagvast - metalen deksel - beugelsluiting - zonder interieur/ tulen - IP 54

 Connecting box with 8 cable entries- impact resistant synthetic housing - metal cover - strap locking - without interior / rubber seals - IP 54

 Verbindungsdose mit 8 x Kabeleingang- Kunststoff Gehäuse - Schlagfest - Metall Deckel - Bügelverschluss - ohne Einsatz / Tüllen - IP 54

 Boîtier d'accouplement, 8 x entrée de câble - Boîte en matière plastique - résistant aux chocs - couvercle métallique - fermeture à étrier - sans insert / joint d'étanchéité - IP 54



WD.018 1

AK 19007

190 x 135 x 80 mm



Interieur - Interior - Einsatz - Intérieur



WD.040 1

AK 19051

14 p./ 6.3 mm - 4 X 14

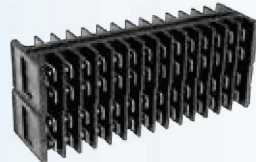

WD.041 1

AK 19053

28 p./ 6.3 mm - 8 X 14

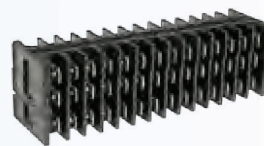

WD.042 1

AK 19052

28 p./ 6.3 mm. - 6 X 14

Tules - Cableseals - Kabeldurchführungstüllen - Joints d'étanchéités



WD.117 Ø 7 mm 1



WD.118 Ø 9.5 mm 1



WD.119 Ø 13 mm 1



WD.115 Ø 17 mm 1



WD.116 Ø closed 1

 Verbindingsdoos ADR / GGVS 16 polig met 16 kabelingangen kunststof huis en deksel - slagvast - beugelsluiting - met interieur - 112 vlakstekeraansluitingen - wartels: 10 x PG 9 + 5 x PG 13.5 + 1 x PG 16 en tulen 4 x PG 9 + 2 x PG 13.5 + 1 x PG 16 - IP 69K

 Verbindungsdose ADR / GGVS 16 polig mit 16 x Kabeleingang - Kunststoff Gehäuse und Deckel - Schlagfest - Bügelverschluss - mit Einsatz - 112 Flachsteckanschlüsse - Verschraubungen: 10 x PG 9 + 5 x PG 13.5+ 1 x PG 16 und Tüllen 4 x PG 9 + 2 x PG 13.5 + 1 x PG 16 - IP 69K

 Connecting box ADR / GGVS GGVS 16 pins with 16 cable entries- impact resistant synthetic housing and cover - strap locking - with interior 112 blade terminals - capnuts: 10 x PG 9 + 5 x PG 13.5 + 1 x PG 16 and rubber seals 4 x PG 9 + 2 x PG 13.5 + 1 x PG 16 - IP 69K

 Boîtier d'accouplement, ADR / GGVS à 16 pôles, 16 x entrée de câble- Boîte et couvercle en matière plastique - résistant aux chocs - fermeture à étrier - avec insert - 112 contacts plans - Ecrous: 10 x PG 9 + 5 x PG 13.5 + 1 x PG 16 et joints d'étanchéité 4 x PG 9 + 2 x PG 13.5 + 1 x PG 16



WD.024 1

GGVS/ADR

167 x 157 x 99 mm



Interieur - Interior - Einsatz - Intérieur



WD.037 1

7 x 8 p / 8 x 4 p - 6.3 x 0.8

 **Verbindingsdoos ADR / GGVS met 16 kabelingen- kunststof huis en deksel - slagvast - met interieur - 11x wartel - Tules: 8x 5.9-6.9mm + 2x 5.9-6.9mm + 1x 11.0-12.0 - DIN 46244 - IP 56 / TP8 - 6.3 vlakstekeraansluitingen**

 **Connecting box ADR / GGVS GGVS with 16 cable entries- impact resistant synthetic housing and cover - with interior- 11x capnut and rubber seals 8x 5.9-6.9mm + 2x 5.9-6.9mm + 1x 11.0-12.0 - DIN 46244 - IP 56 / TP8 - 6.3 blade terminal connections**

 **Verbindingsdose ADR / GGVS mit 16 x Kabeleingang - Kunststoff Gehäuse und Deckel - Schlagfest - mit Einsatz - 11x Verschraubung und Tüllen 8 X 5.9-6.9mm + 2x 5.9-6.9mm + 1x 11.0-12.0 - DIN 46244 - IP 56 / TP8 - 6.3 Flachsteckanschlüsse**

 **Boîtier d'accouplement, ADR / GGVS, 16 x entrée de câble- Boîte et couvercle en matière plastique - résistant aux chocs - avec insert - 11x Ecou et joints d'étanchéité 8x 5.9-6.9mm + 2x 5.9-6.9mm + 1x 11.0-12.0 - DIN 46244 - IP 56 / TP8 - 6.3 contacts plans**



WD.019 1

P2450 - GGVS/ADR  
210 x 115 x 93 mm



 **Verbindingsdoos 8 polig met 6 kabelingen- - kunststof huis en deksel - slagvast - met interieur en tulen 6 x PG 16 - IP 66**

 **Connecting box 8 pins with 6 cable entries- impact resistant synthetic housing and cover - with interior and rubber seals 6 x PG 16 - IP 66**

 **Verbindingsdose 8 polig mit 6 x Kabeleingang Kunststoff Gehäuse und Deckel - Schlagfest - mit Einsatz und Tüllen 6 x PG 16 - IP 66**





 **Boîtier d'accouplement, à 8 pôles, 6 x entrée de câble- Boîte et couvercle en matière plastique - résistant aux chocs - avec insert et joints d'étanchéité 6 x PG 16 - IP 66**



WD.033 1

P2450 - GGVS/ADR  
210 x 115 x 93 mm



 **Wartels** IP68  
 **Capnuts**  
 **Verschraubungen**  
 **Ecoures**

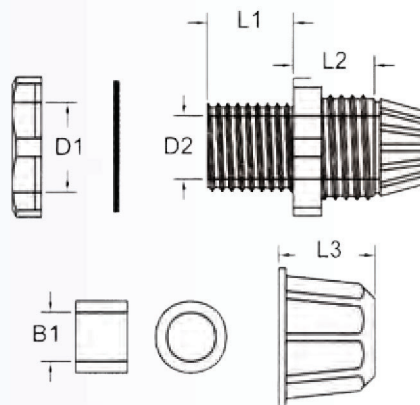

| Art.nr | D1 | P    | D2   | B1   | L1   | L2   | L3   | cabl  | vpe   |
|--------|----|------|------|------|------|------|------|-------|-------|
| WD.050 | 12 | 1.25 | 8.3  | 6.0  | 7.9  | 12.1 | 13.3 | 3-6.5 | 1 pcs |
| WD.051 | 16 | 1.5  | 10.9 | 9.6  | 15.7 | 14.4 | 16.7 | 5-10  | 1 pcs |
| WD.052 | 20 | 1.5  | 14.8 | 12.9 | 15.0 | 19.5 | 18.4 | 10-14 | 1 pcs |
| WD.053 | 25 | 1.5  | 18.6 | 16.4 | 15.0 | 18.7 | 22.3 | 13-18 | 1 pcs |
| WD.054 | 32 | 1.5  | 26   | 23.4 | 14.7 | 20.3 | 26.2 | 18-25 | 1 pcs |
| WD.055 | 40 | 1.5  | 33   | 30.6 | 17.7 | 23.4 | 31.9 | 22-32 | 1 pcs |
| WD.056 | 50 | 1.5  | 41.2 | 38.2 | 17.3 | 25.7 | 31.6 | 30-38 | 1 pcs |

Materiaal: Nylon P66 - UL 94 V-2

Standaard kleur: zwart  
Op aanvraag leverbaar in:  
rood - wit - grijs - blauw - geel

